













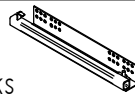
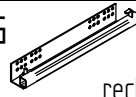



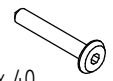

Inhalt - Contents - Contenu - Inhoud - contenuto -contenido-conteúdo - περιεχόμενο

Wickelkommode changing unit Commode Kommode

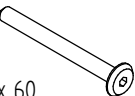
Regal Holly 07 915

Beschlagbeutel:

A  8 x	B  15 ohne Rand 8 x	C  8 x 30 2 x	
D  3x16 9 x	E  6,3 x 10 4 x	F  links 1 x	
G  rechts 1 x	H  1 x	I  5 x	
J  12 x	K  12 x	L  2 x	
M  M4 x 20 2 x	N  4 x	O  M6 x 40 4 x	T  6,3x50 2 x
P  M6 x 60 4 x	Q  4 x	R  1 x	S  1 x

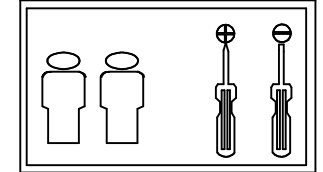
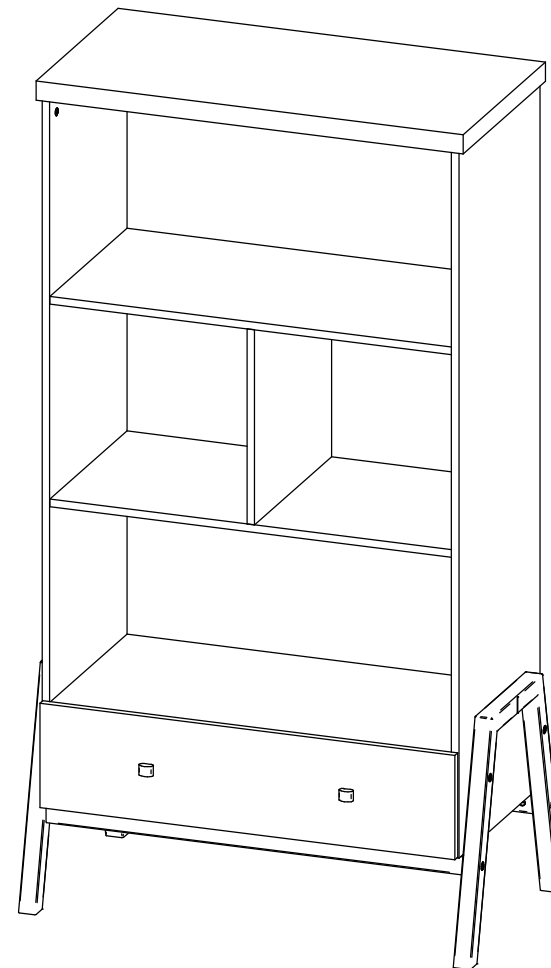

Inhalt - Contents - Contenu - Inhoud - contenuto - contenido-conteúdo - περιεχόμενο

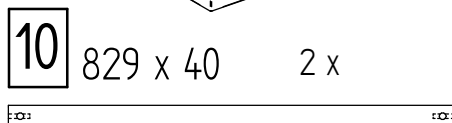
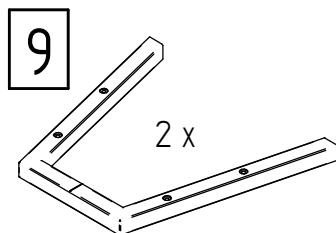
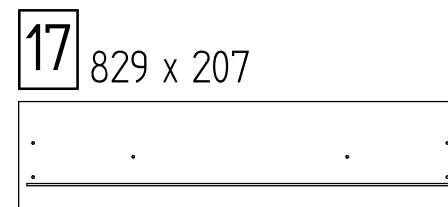
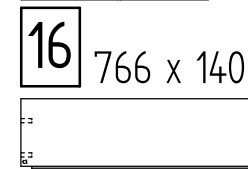
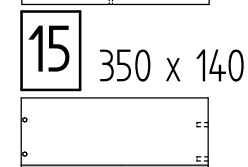
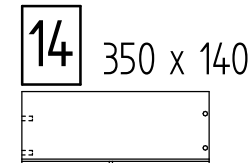
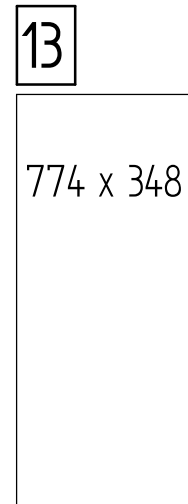
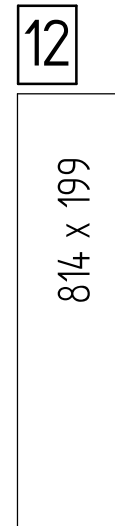
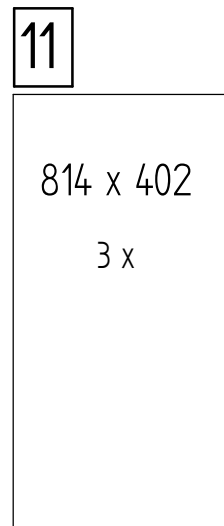
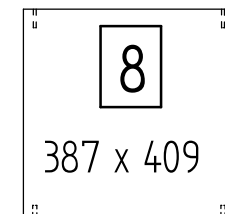
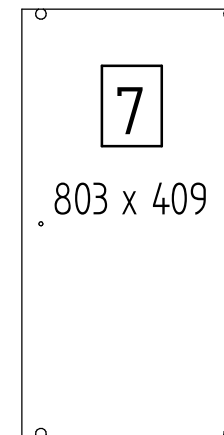
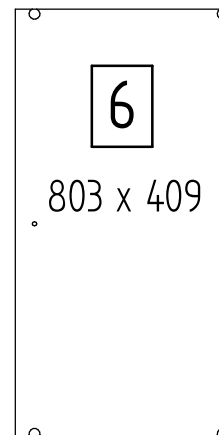
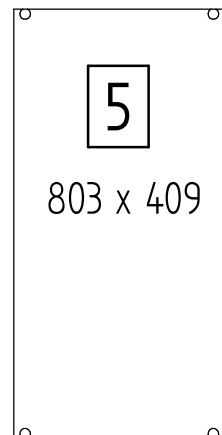
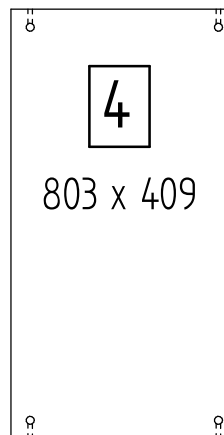
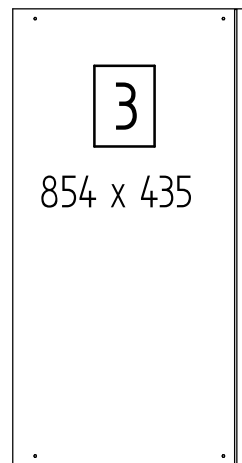
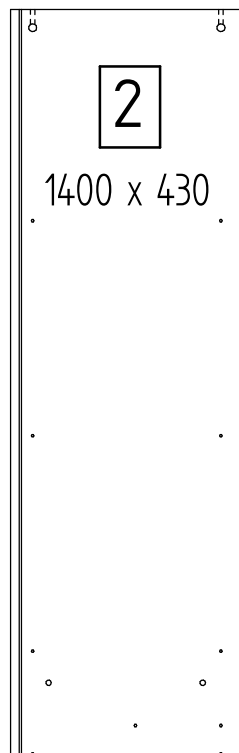
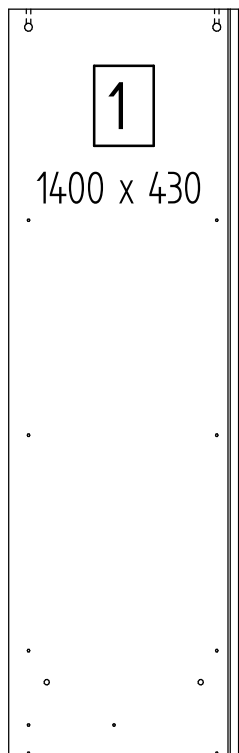

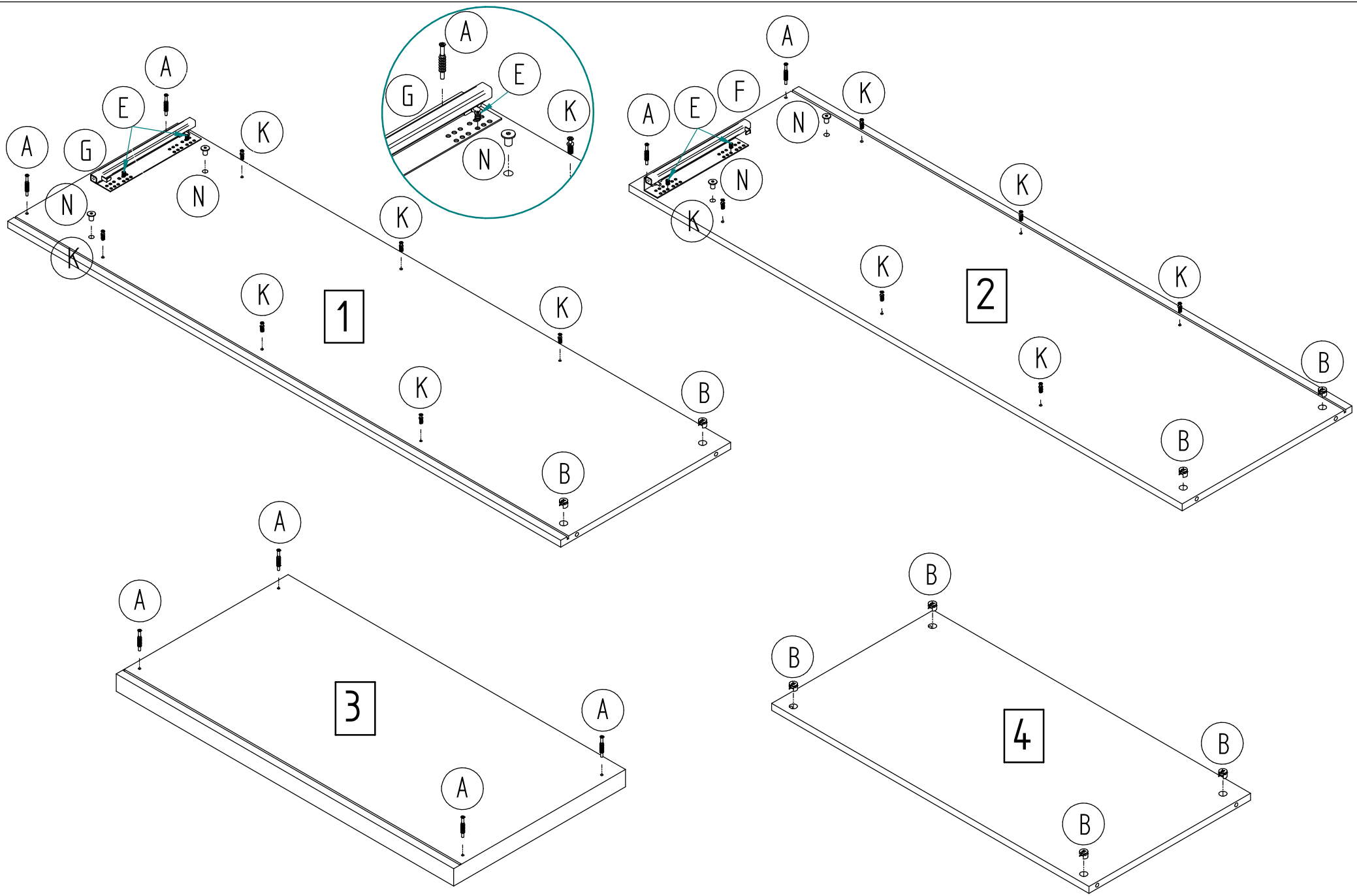

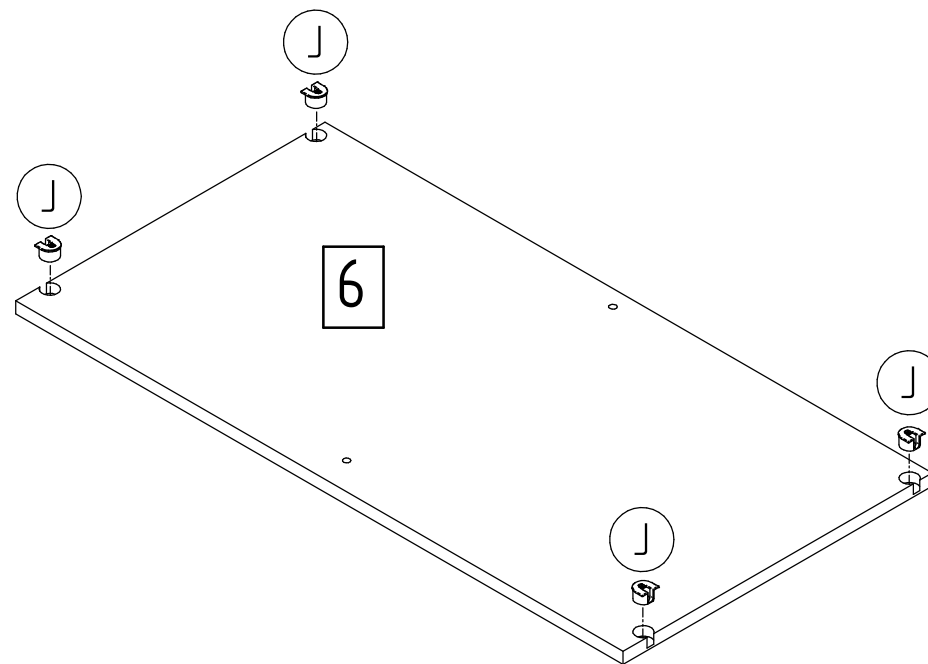
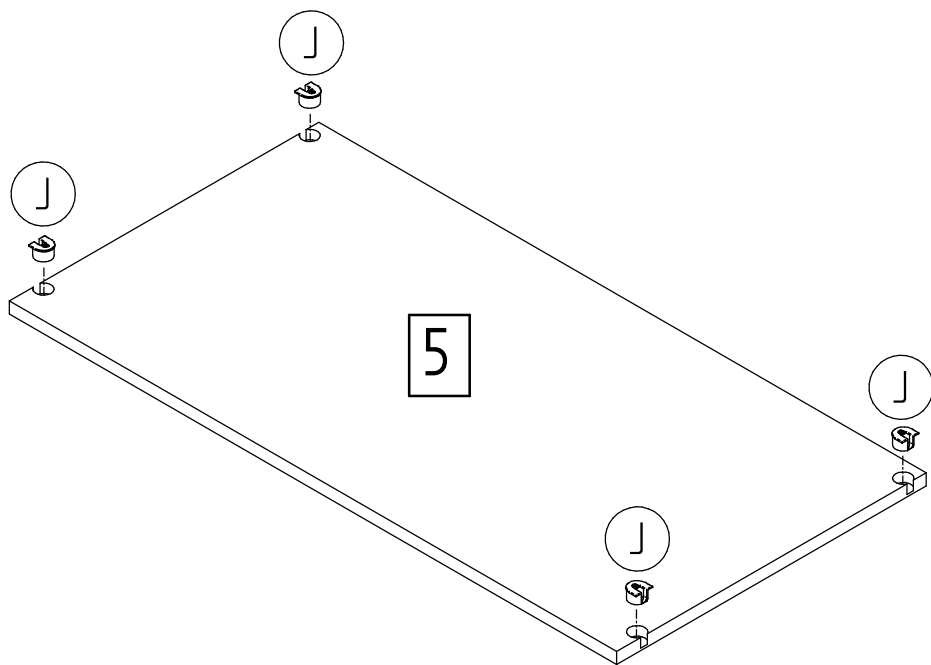

Vor weiterer Montage der Beschläge den Leim 30 min abbinden lassen.
 Before further installation of the fittings the glue thicken for 30 minutes.
 Avant l'installation ultérieure des raccords, la colle épaisse pendant 30 minutes.
 Voor verdere montage van het beslag de lijm dik gedurende 30 minuten.
 Prima ulteriore installazione dei raccordi addensare la colla per 30 minuti.
 Antes de la instalación posterior de los accesorios de la cola espesar durante 30 minutos.
 Antes da instalação posterior dos acessórios a engrossar cola durante 30 minutos.
 Πριν από την περαιτέρω εγκατάσταση των εξαρτημάτων πικνώσει η κόλλα για 30 λεπτά.

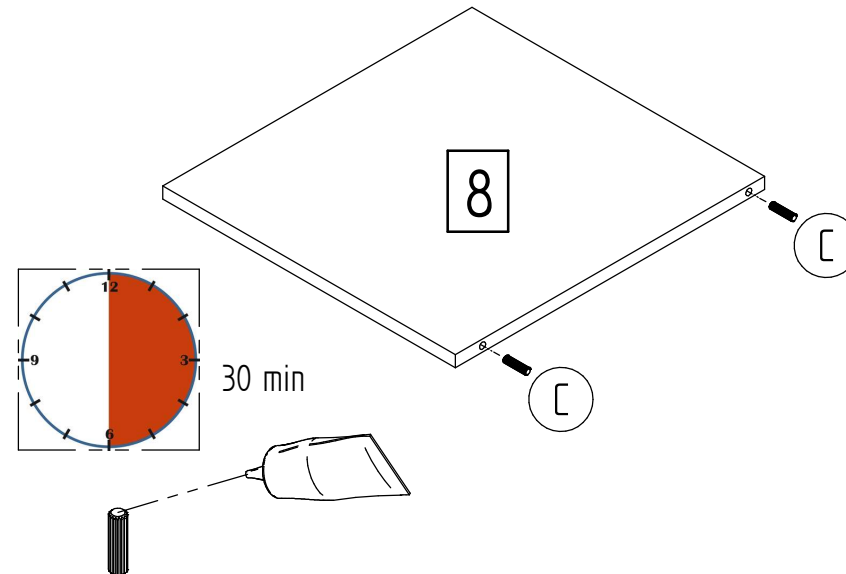
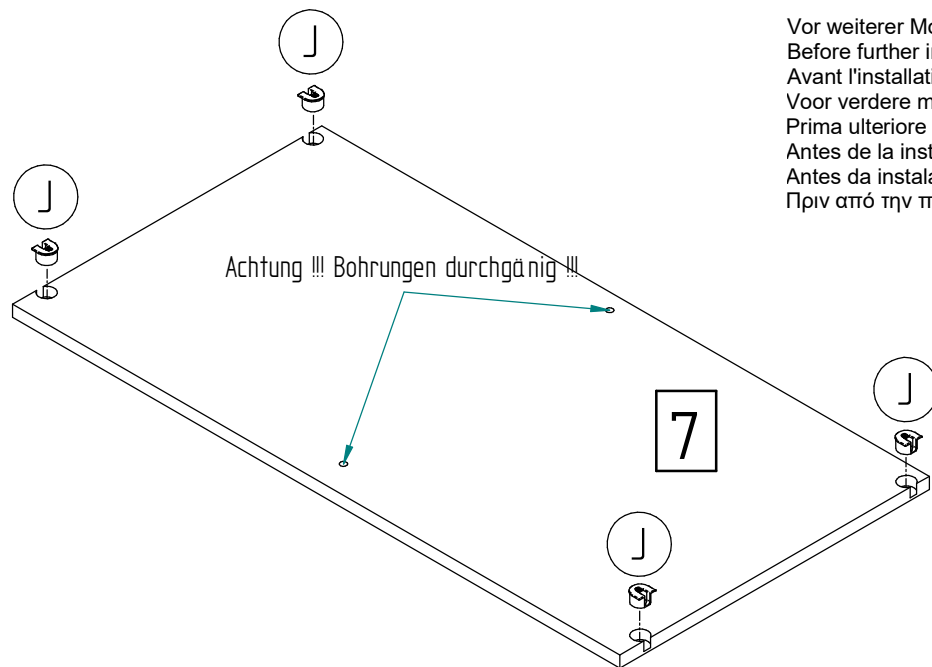

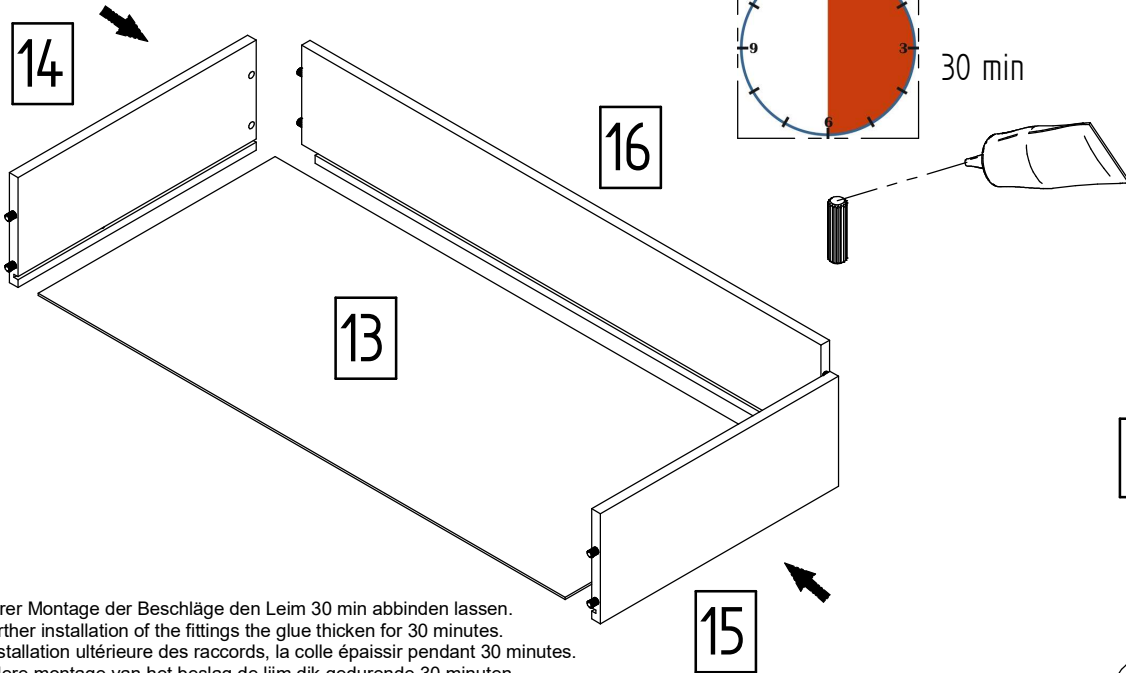

Vor weiterer Montage der Beschläge den Leim 30 min abbinden lassen.
 Before further installation of the fittings the glue thicken for 30 minutes.
 Avant l'installation ultérieure des raccords, la colle épaissir pendant 30 minutes.
 Voor verdere montage van het beslag de lijm dik gedurende 30 minuten.
 Prima ulteriore installazione dei raccordi addensare la colla per 30 minuti.
 Antes de la instalación posterior de los accesorios de la cola espesar durante 30 minutos.
 Antes da instalação posterior dos acessórios a engrossar cola durante 30 minutos.
 Πριν από την περαιτέρω εγκατάσταση των εξαρτημάτων πικνώσει η κόλλα για 30 λεπτά.

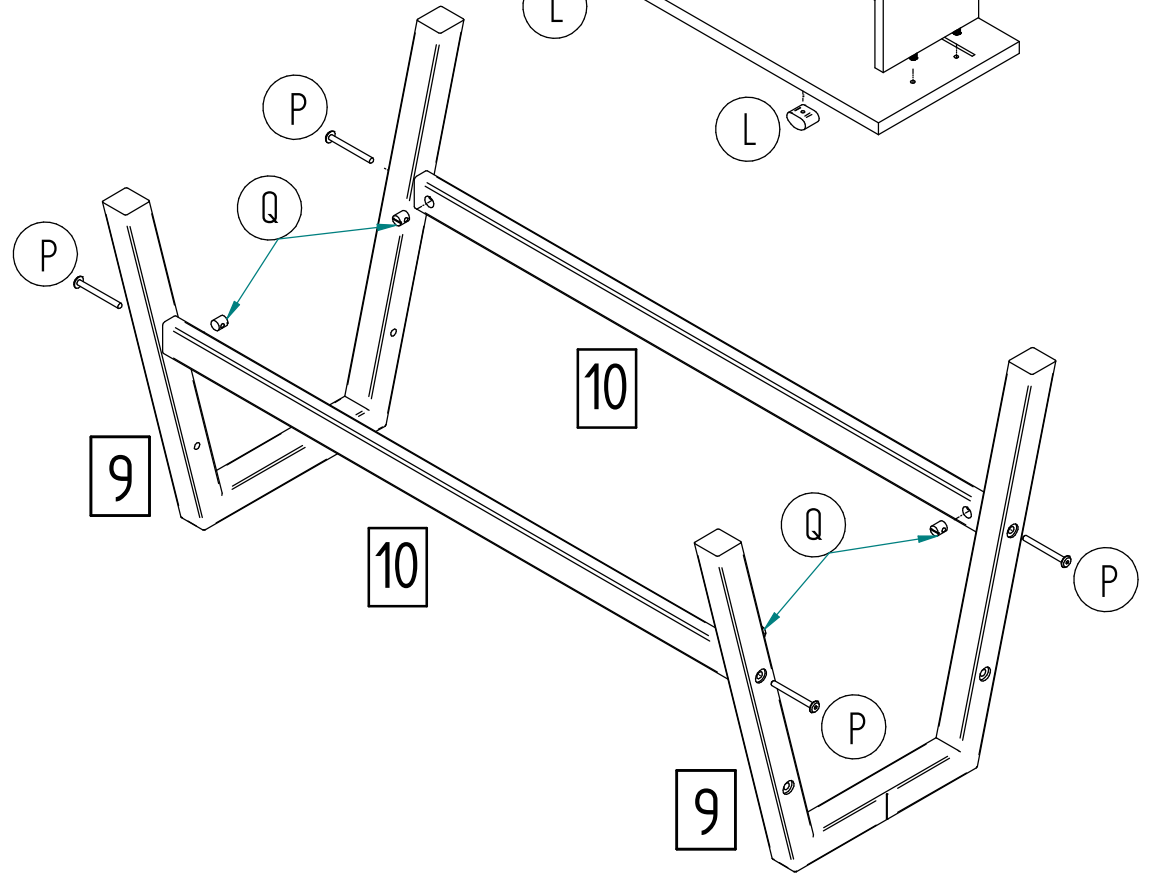
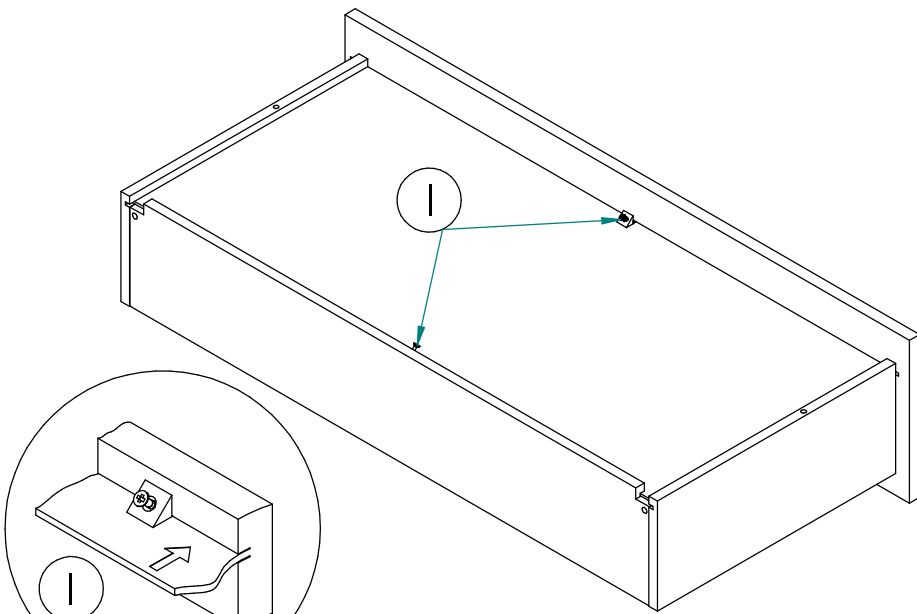
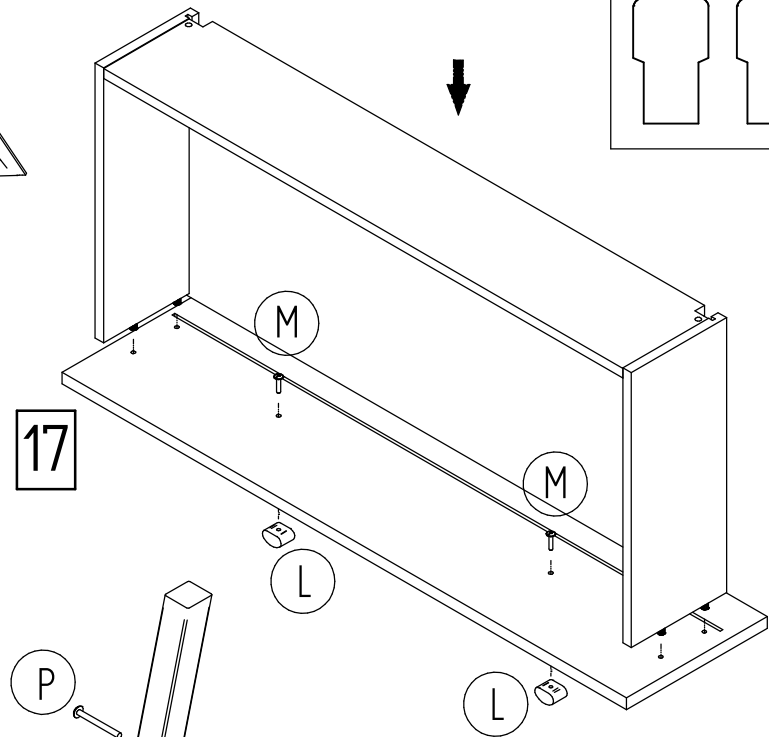
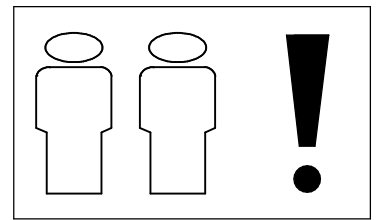

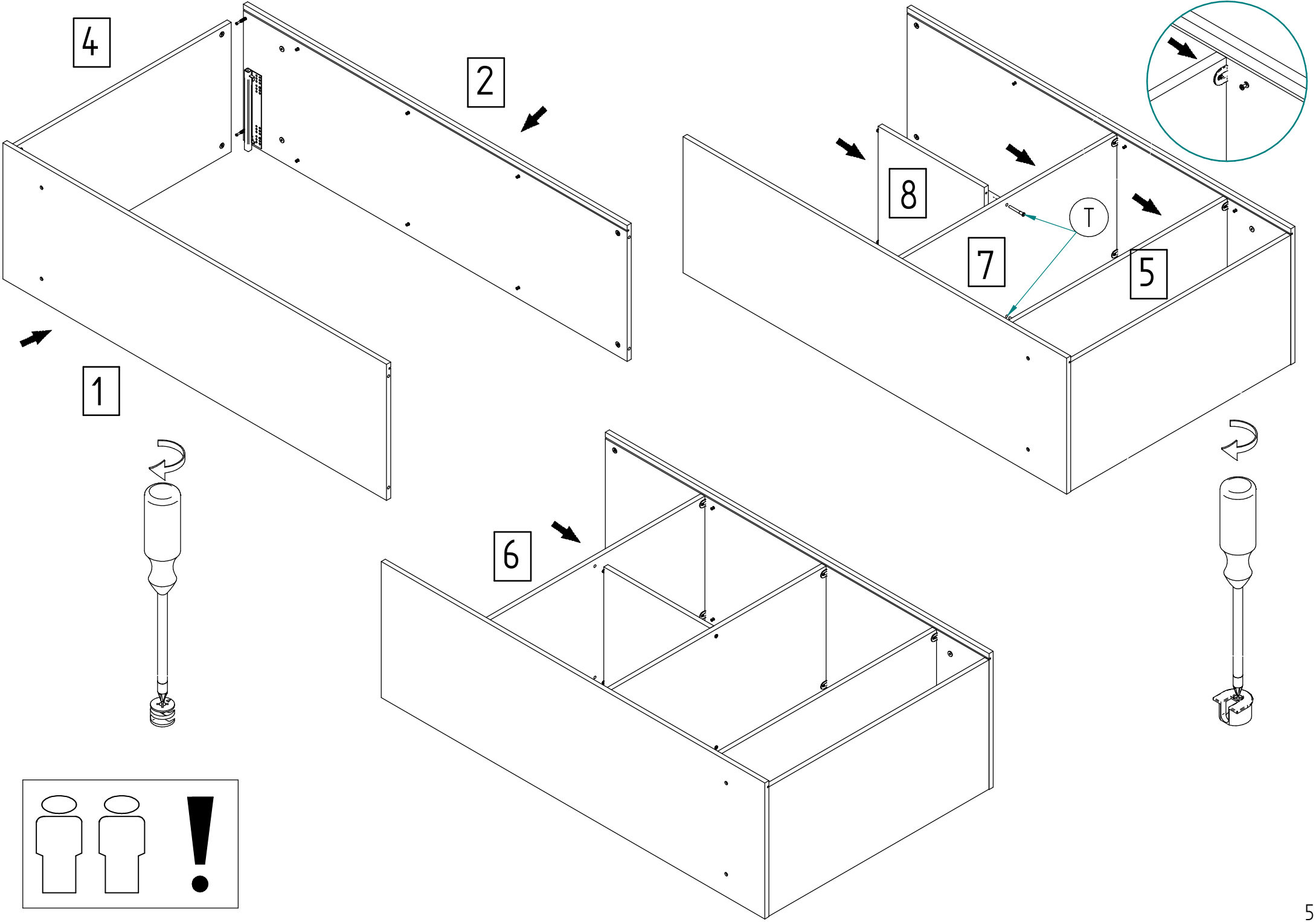

4

2

8

7

5

T

1

6

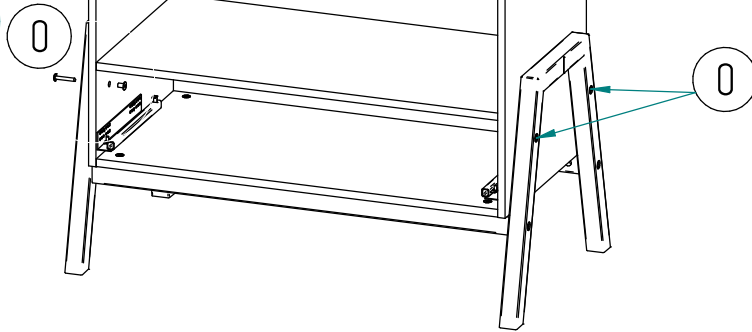
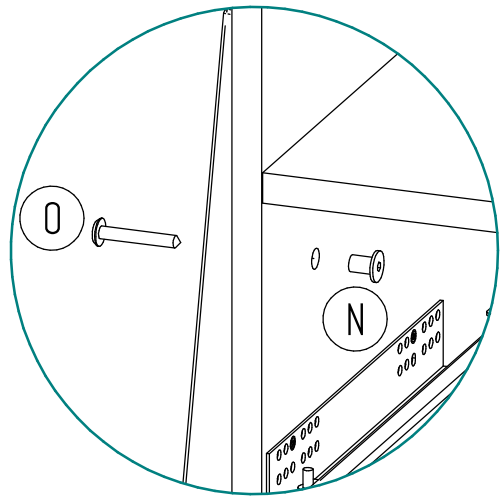
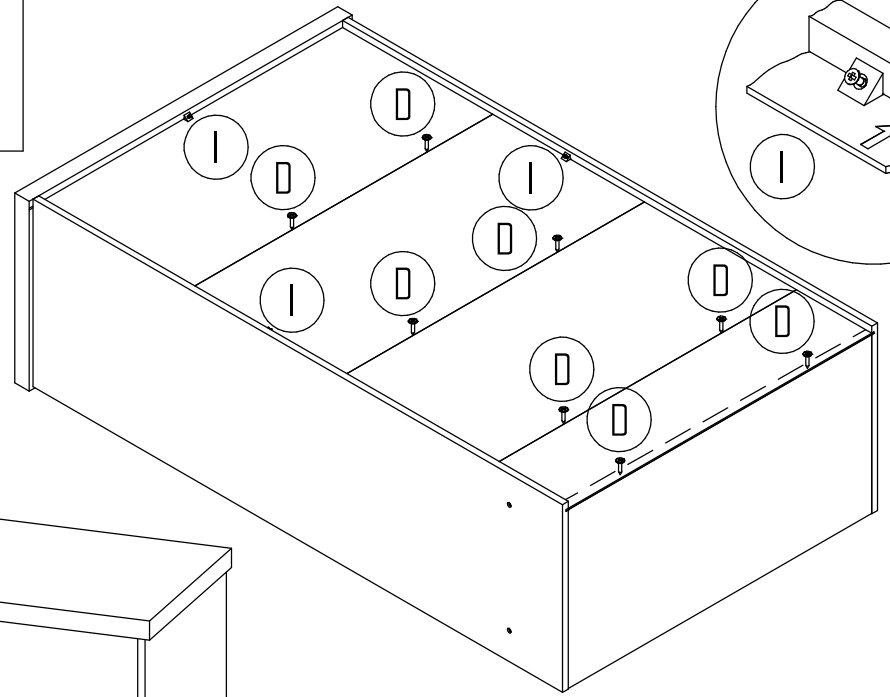
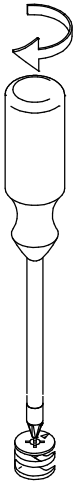
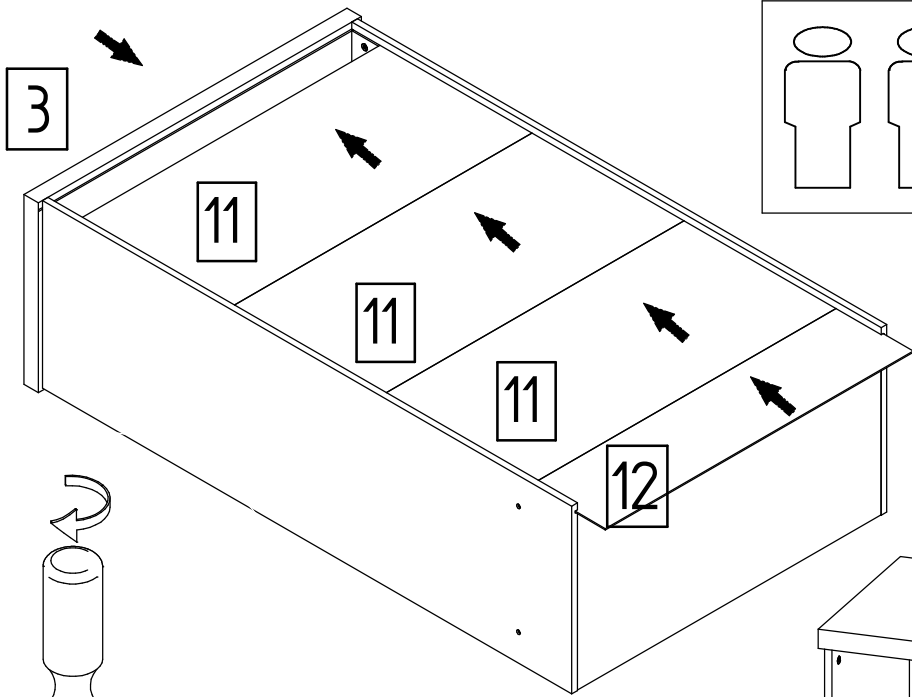

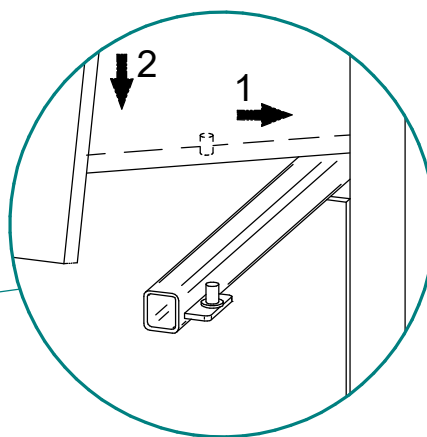
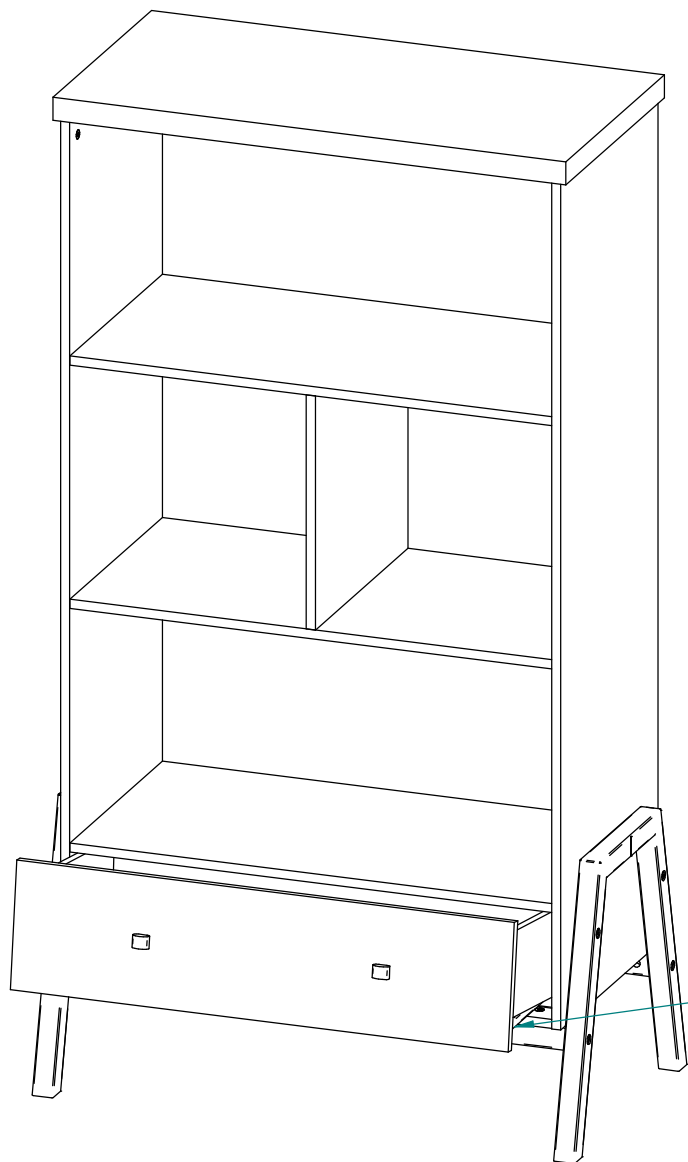

www.schardt.com

... weitere Infos über unsere Produkte unter
... plus d'informations sur nos produits sous
... altre informazione degli prodotti di noi sotto

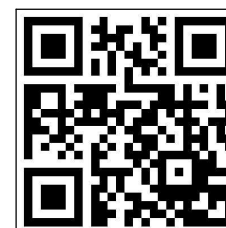

Schardt GmbH & Co. KG
Am Riegel 15
96268 Mitwitz
Tel. 09266/9907-0
Fax 09266/9907-77
E-Mail: info@schardt.com