

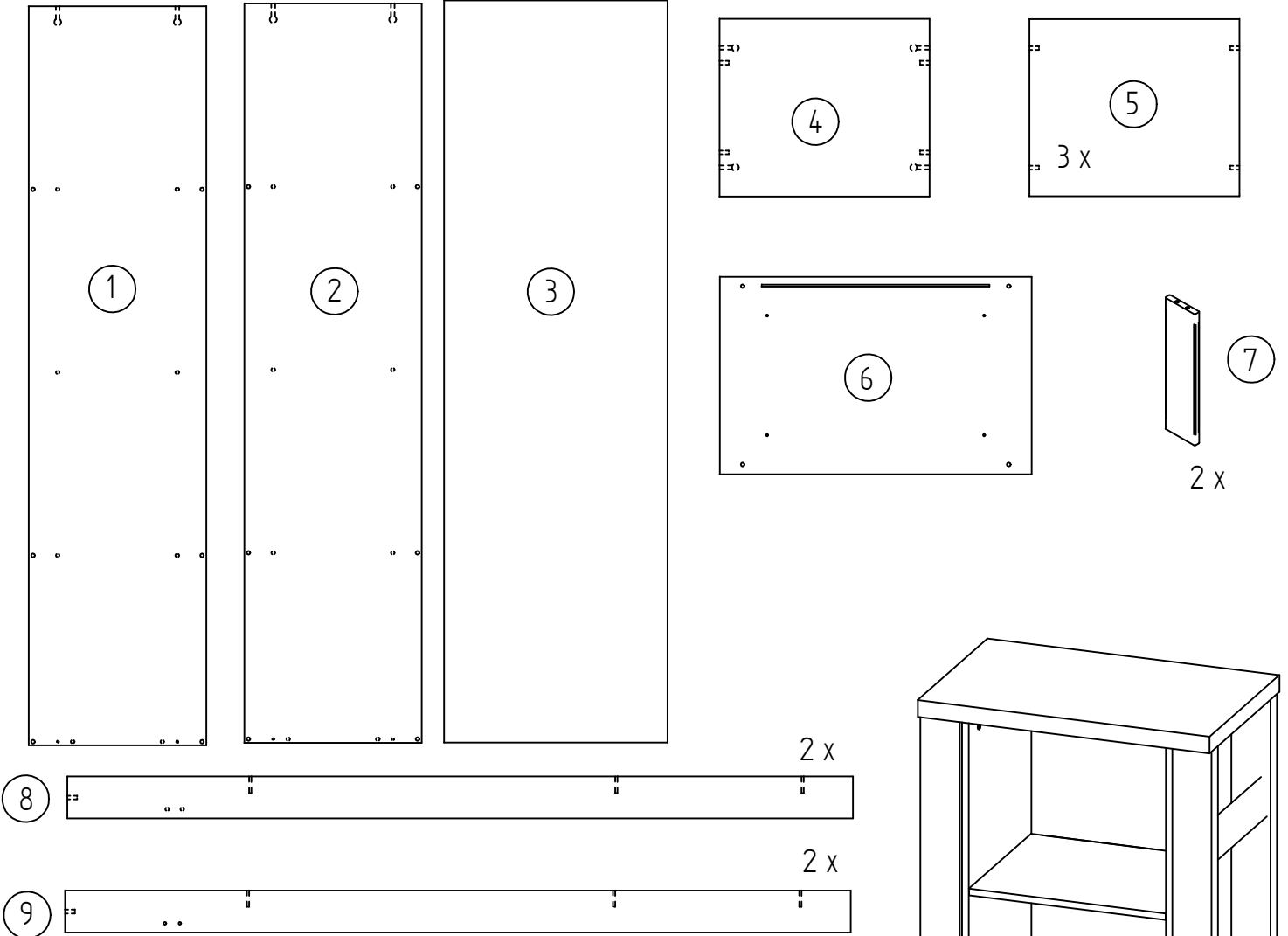







www.schardt.com

Georg Schardt KG
 Am Riegel 15
 96268 Mitwitz
 Tel. 09266/9907-0
 Fax 09266/9907-77
 eMail: info@schardt.com

Montageanleitung - Assembly instructions - Instructions de montage - Montageaanwijzing



Inhalt - Contents - Contenu - Inhoud

A 	B 	C  8 x 30
8 x	8 x	28 x
D 	E 	F  7 x 50
1 x	20 x	12 x

**Standregal
 Shelf
 Tablette
 Rek**

**Milano II
 07 646**

