



Montageanleitung - Assembly instructions- instructions de montage – Montageaawijzing-Istruzioni per l'installazione - indicaciones de montaje - Instruções de instalação- Οδηγίες Εγκατάστασης

Scharardt GmbH & Co. KG  
 Am Riegel 15  
 96268 Mitwitz  
 Tel. 09266/9907-0  
 Fax 09266/9907-77  
 E-Mail: info@scharardt.com

Inhalt - Contents - Contenu - Inhoud - contenido - contenido-conteúdo - περιεχόμενο

## Miami 06 796 Schrank 3 Türen

Beschlagbeutel:

A		24 X	B		28 X	D		E		12 X
F		8 X	G		2 X	H		I		3 X
J		6 X	K		3 X	L		M		4 X
N		2 X	O		4 X	P		R		4 X
S		4 X	T		6 X	U		V		4 X
W		2 X								

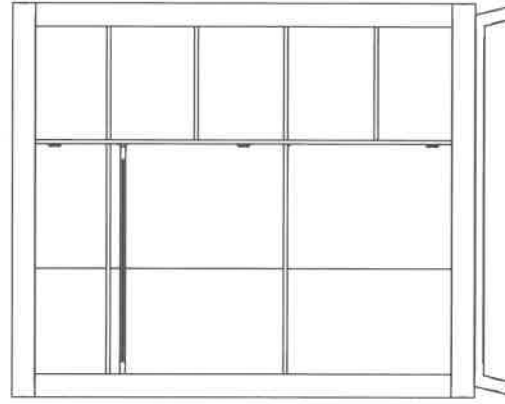
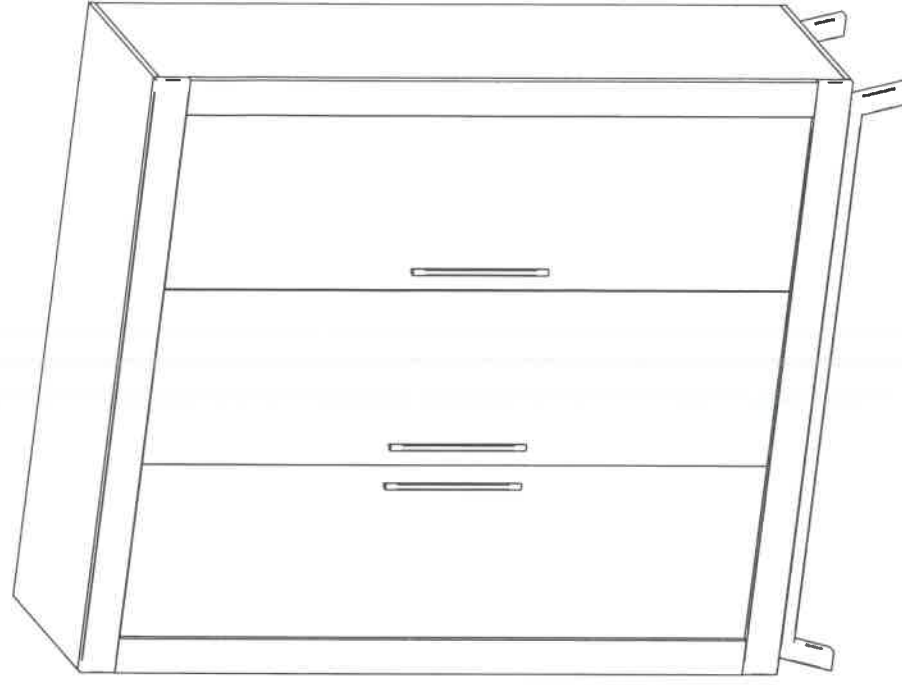
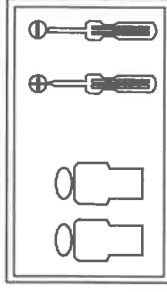

**Inhalt - Contents - Contenu - Inhoud - contenido - conteúdo - περιεχόμενο**

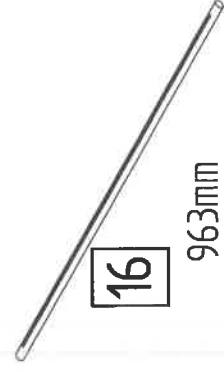
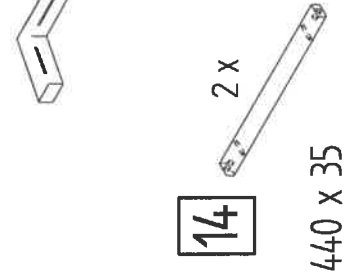
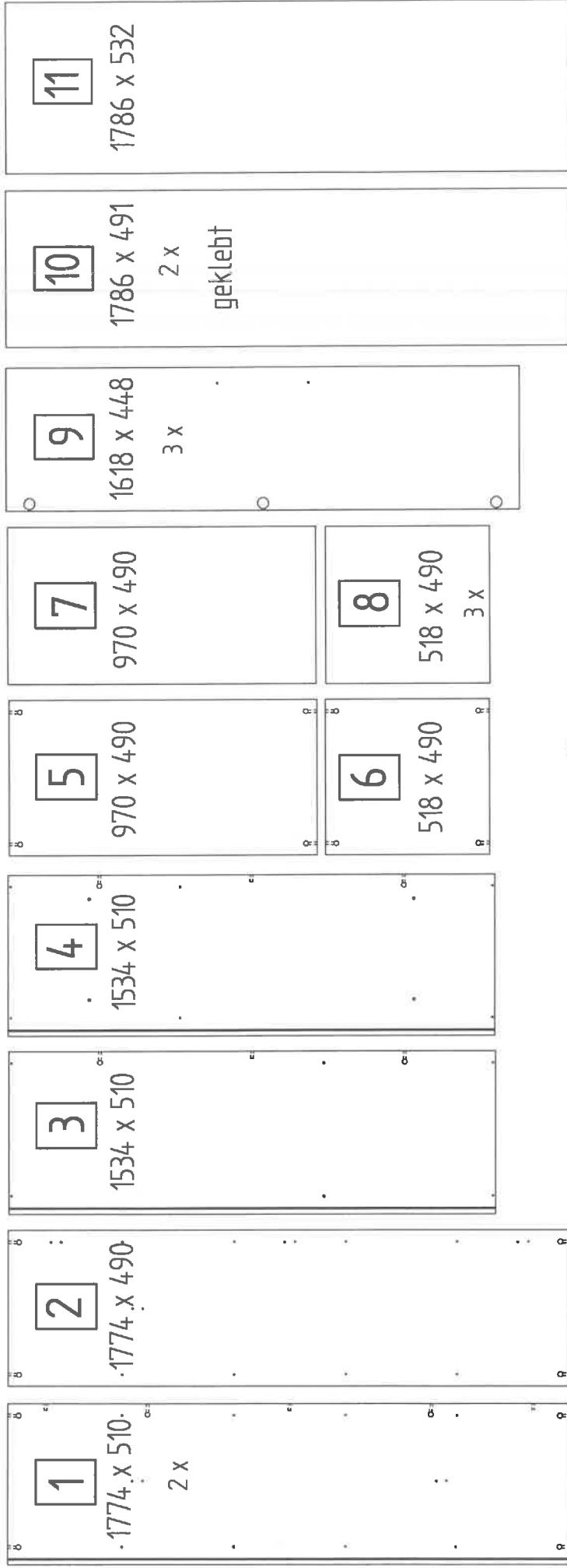

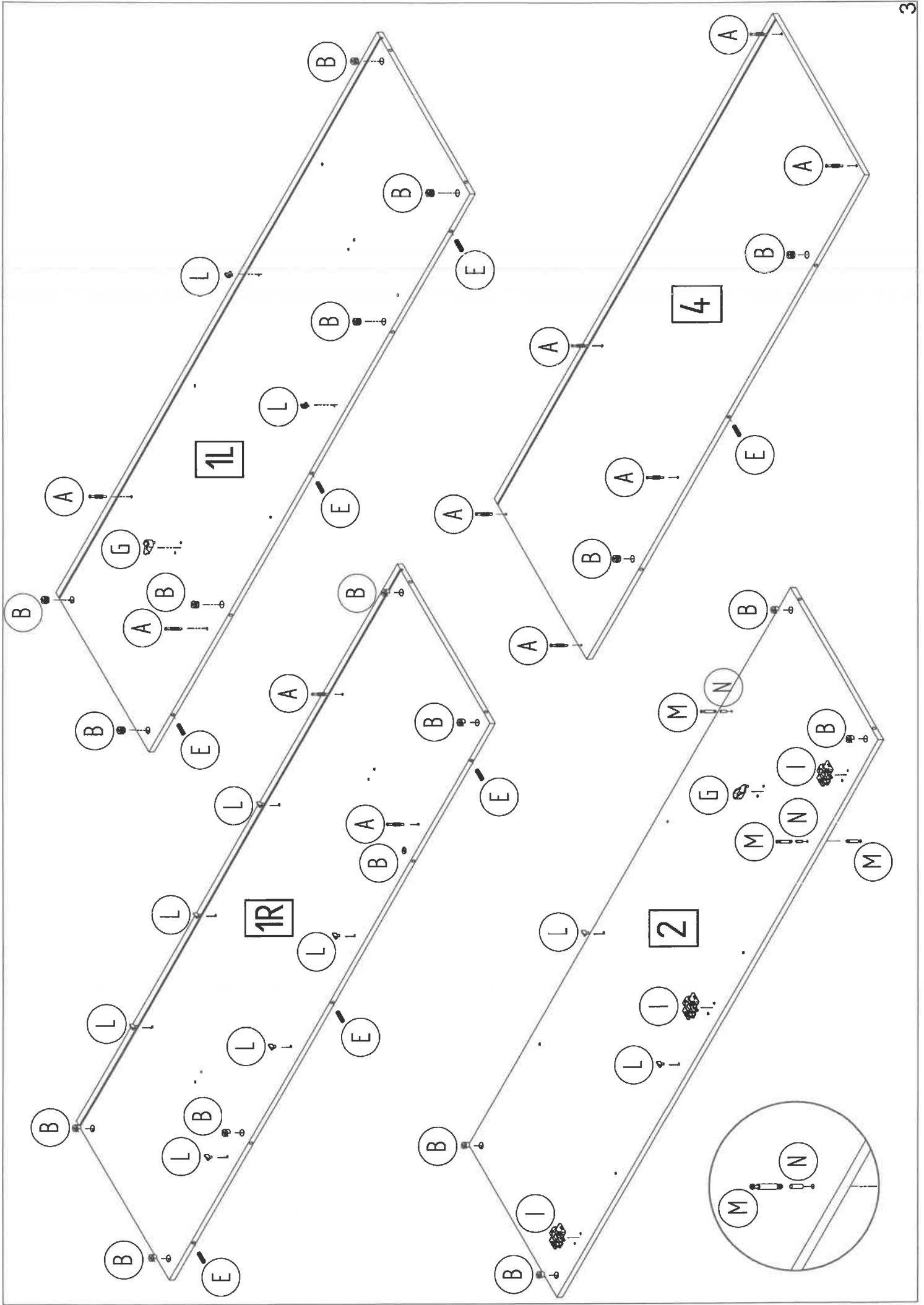

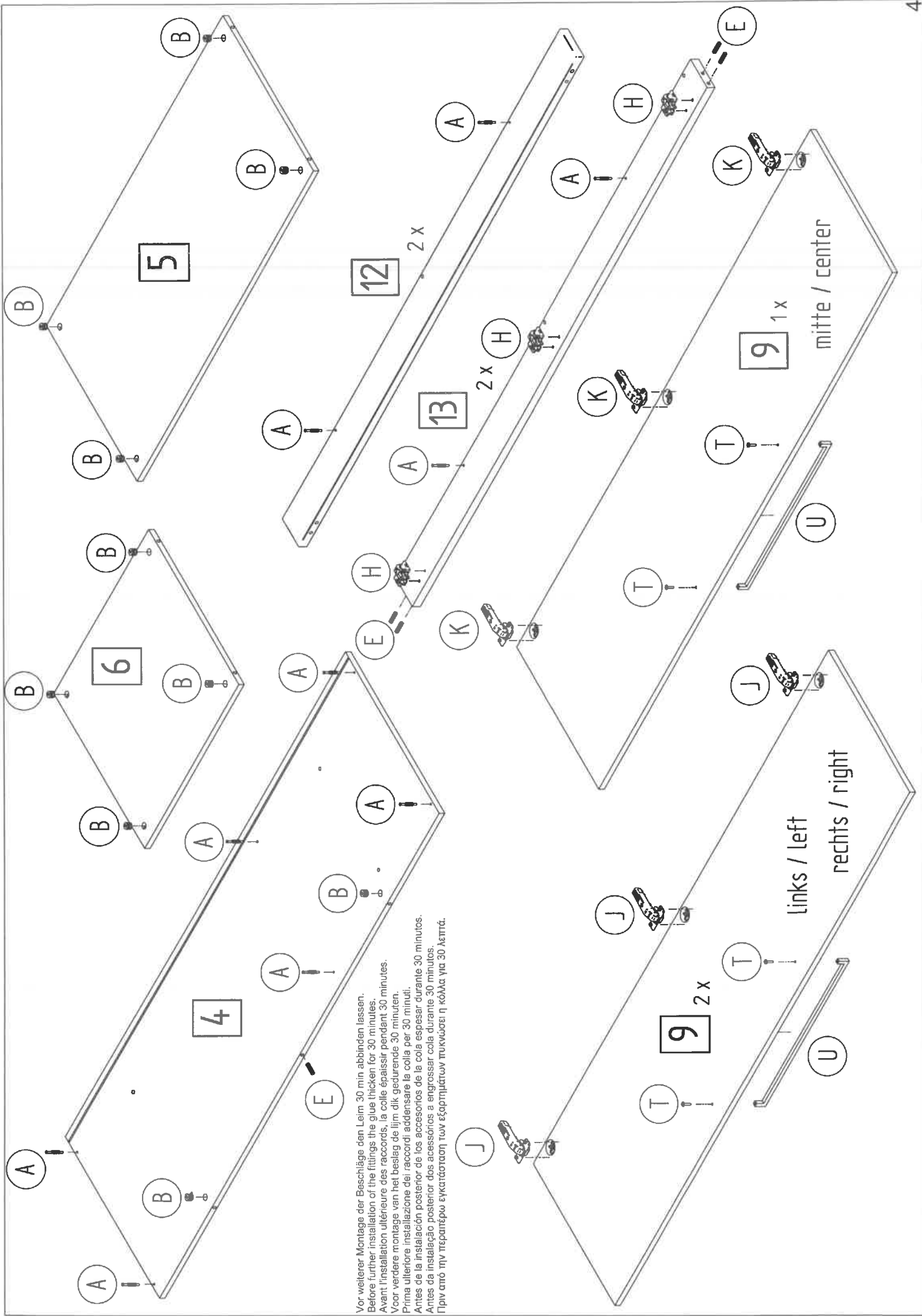

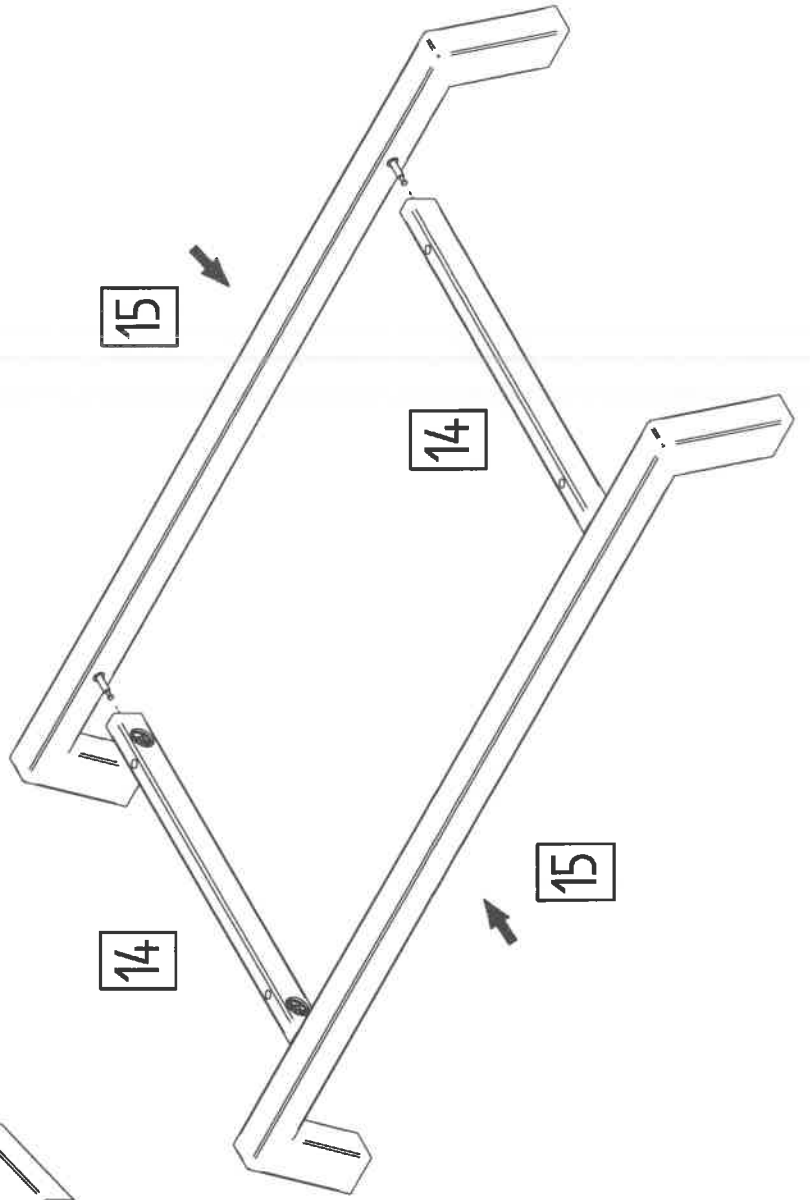
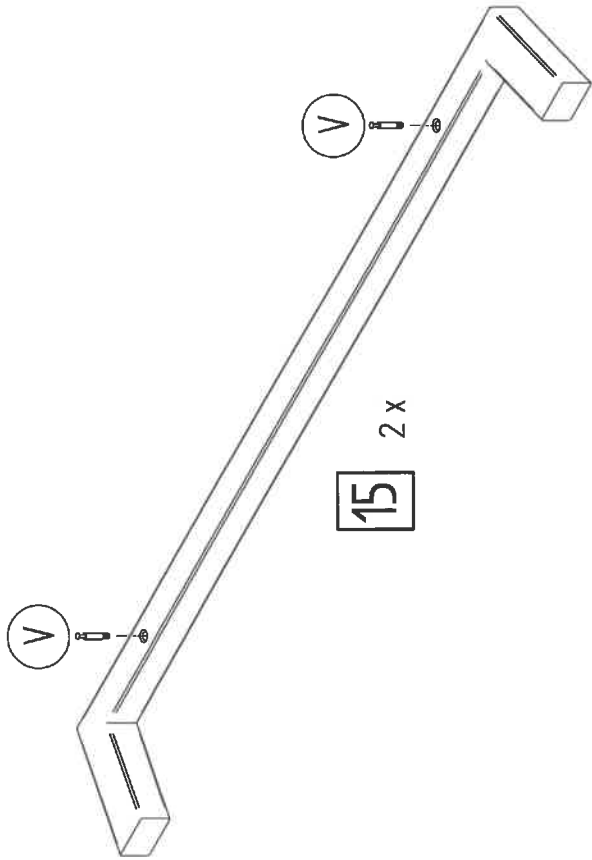
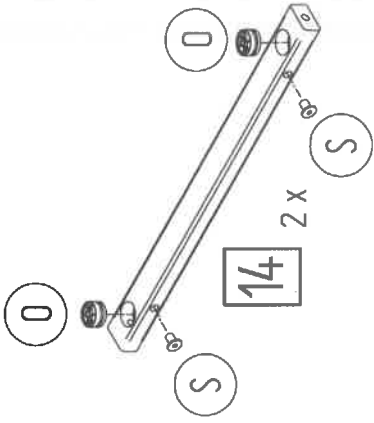

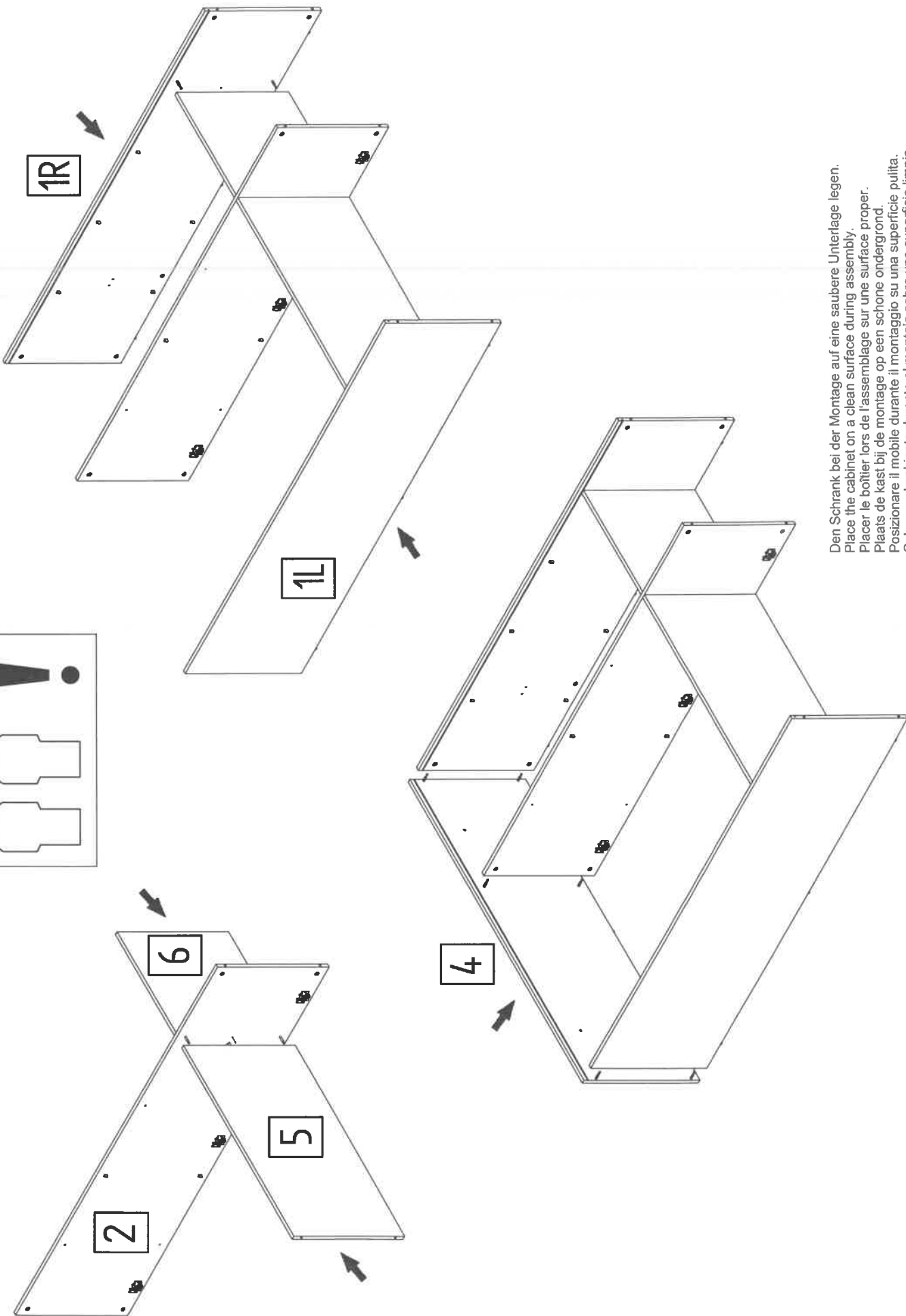
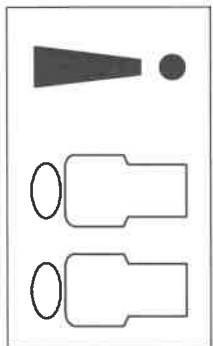

Den Schrank bei der Montage auf eine saubere Unterlage legen.  
Place the cabinet on a clean surface during assembly.  
Placer le boîtier lors de l'assemblage sur une surface propre.  
Plaats de kast bij de montage op een schone ondergrond.  
Posizionare il mobile durante il montaggio su una superficie pulita.  
Coloque el gabinete durante el montaje sobre una superficie limpia.  
Coloque o gabinete durante a montagem sobre uma superfície limpa.  
Τοποθετήστε το υποσυγκό σύμβουλο κατά τη συναρμολόγηση σε μια καθαρή επιφάνεια.

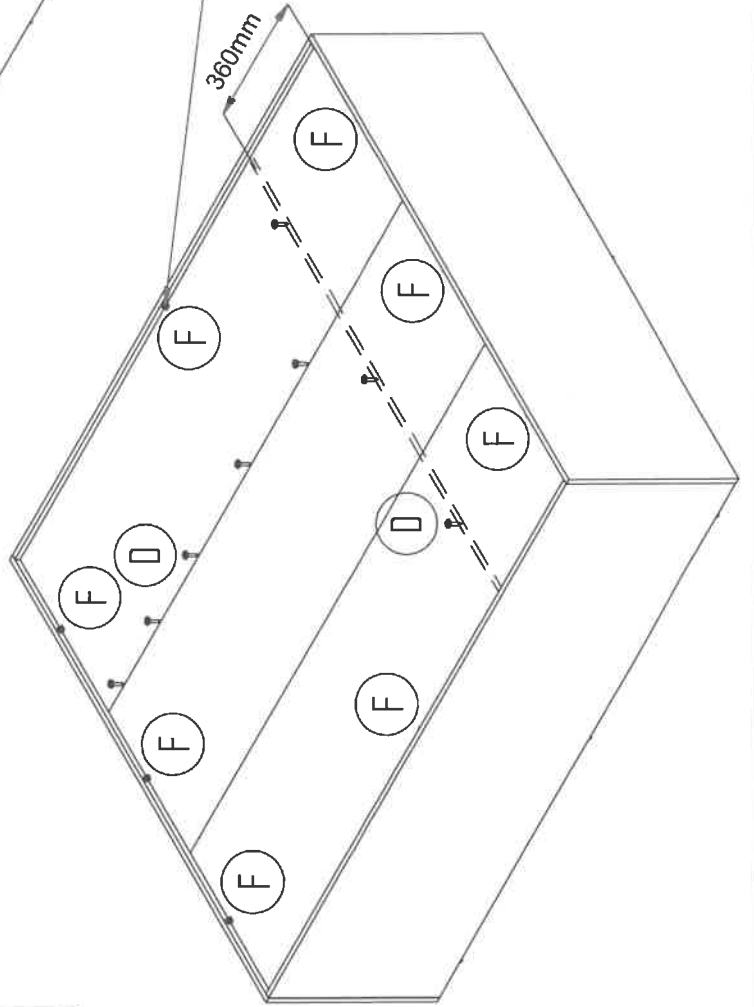
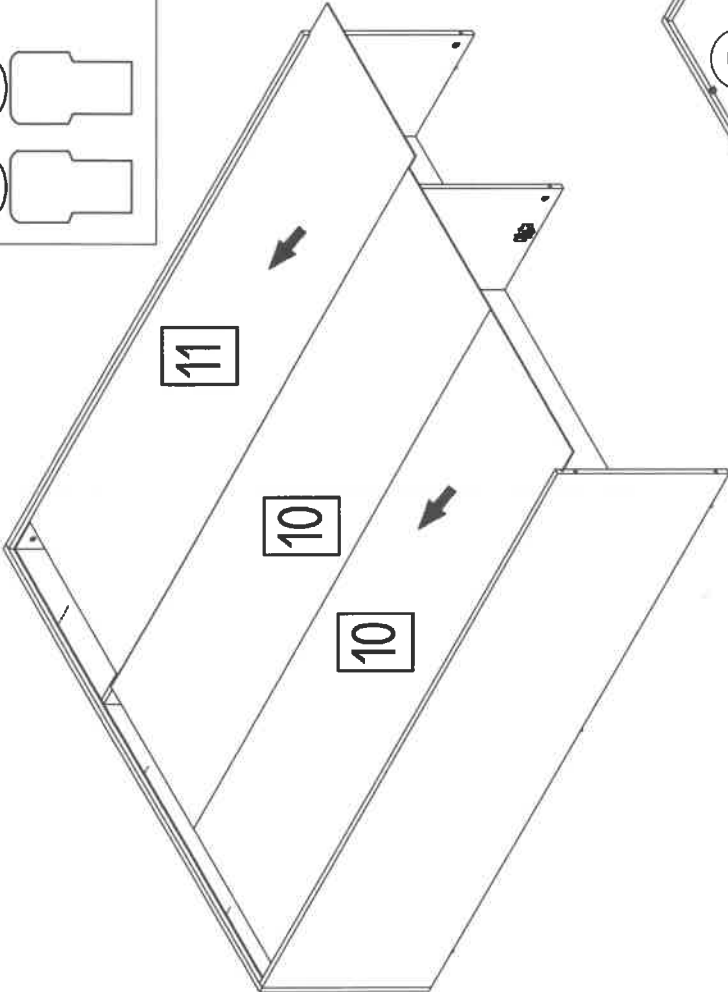
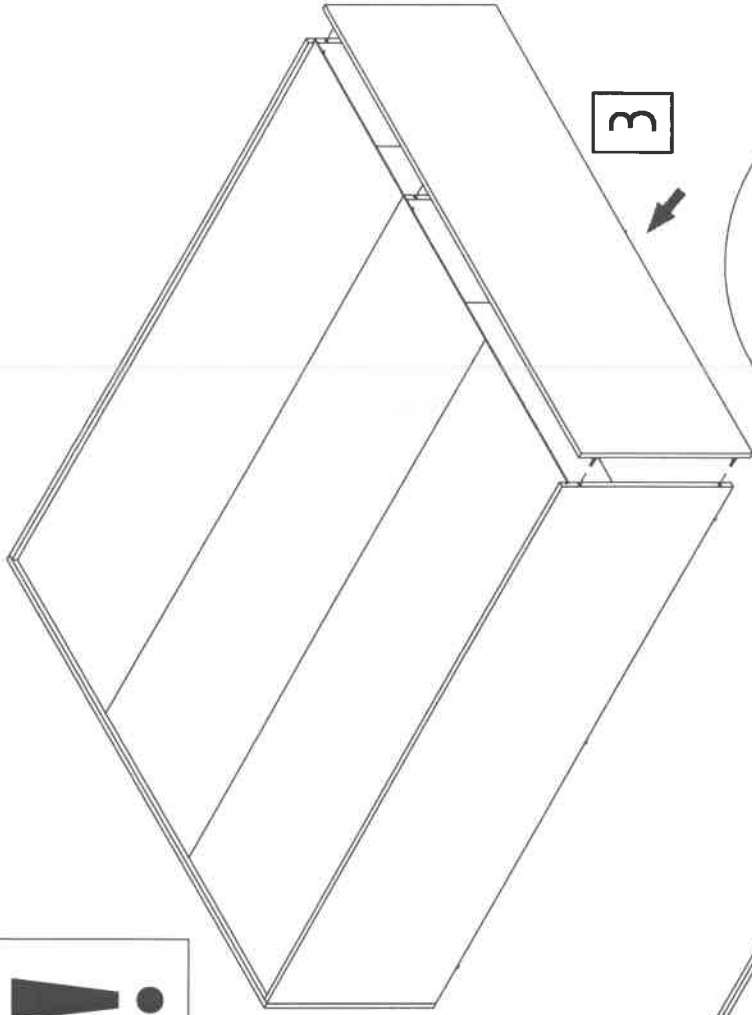
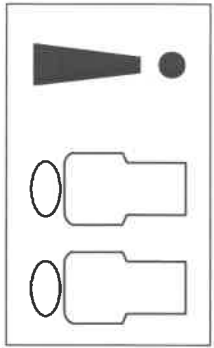

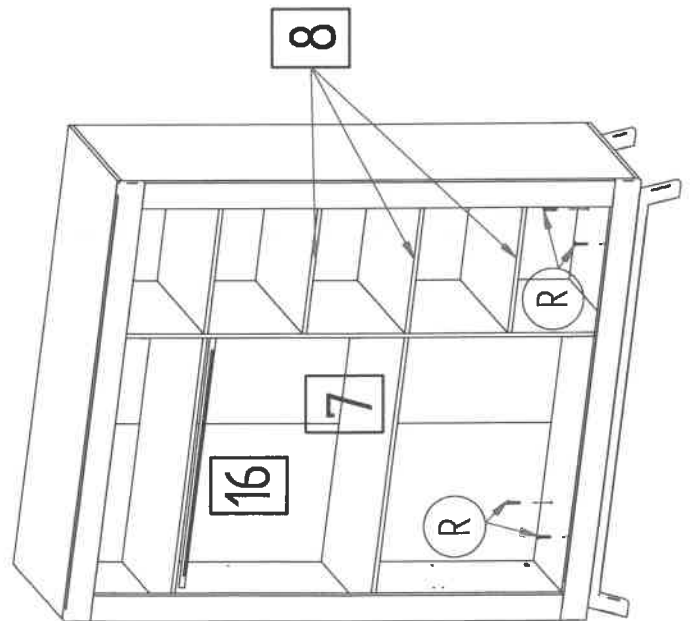
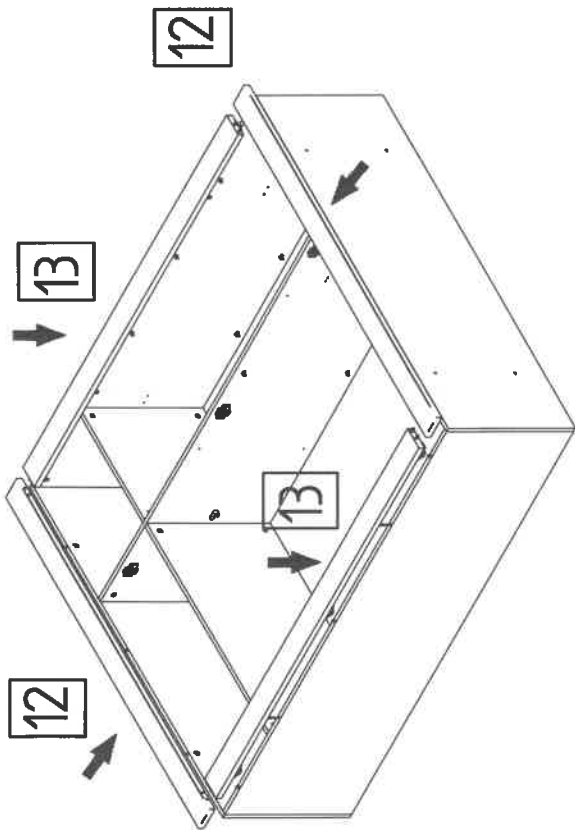
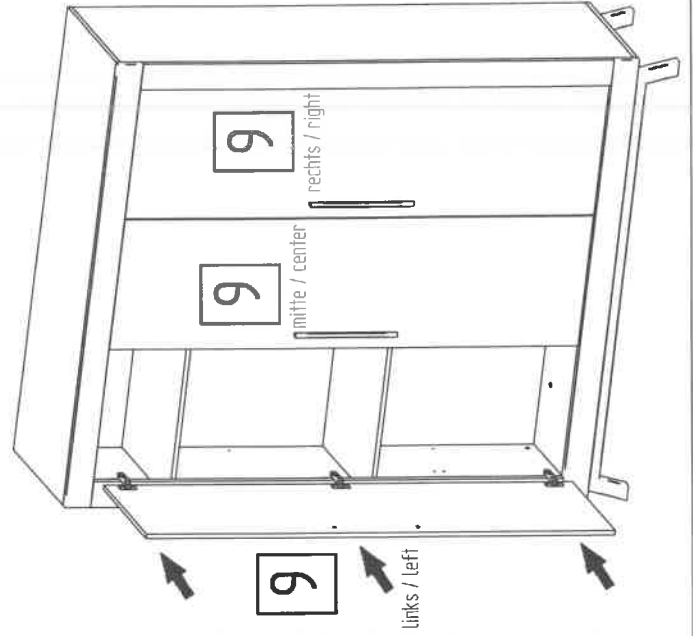
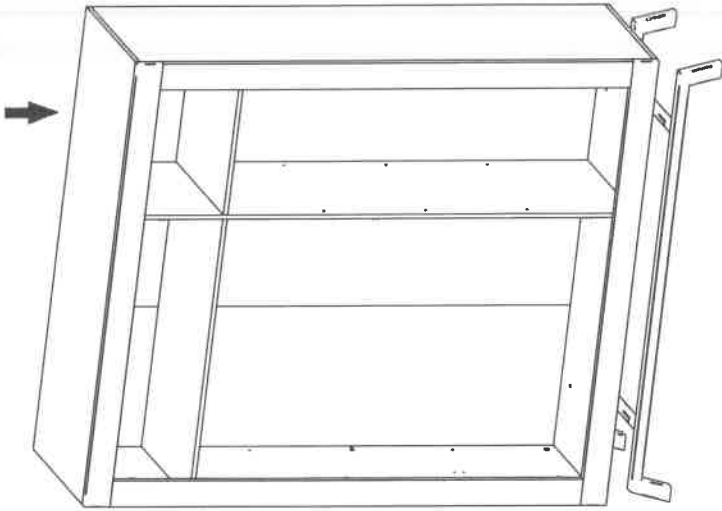



... weitere Infos über unsere Produkte unter

[www.schardt.com](http://www.schardt.com)

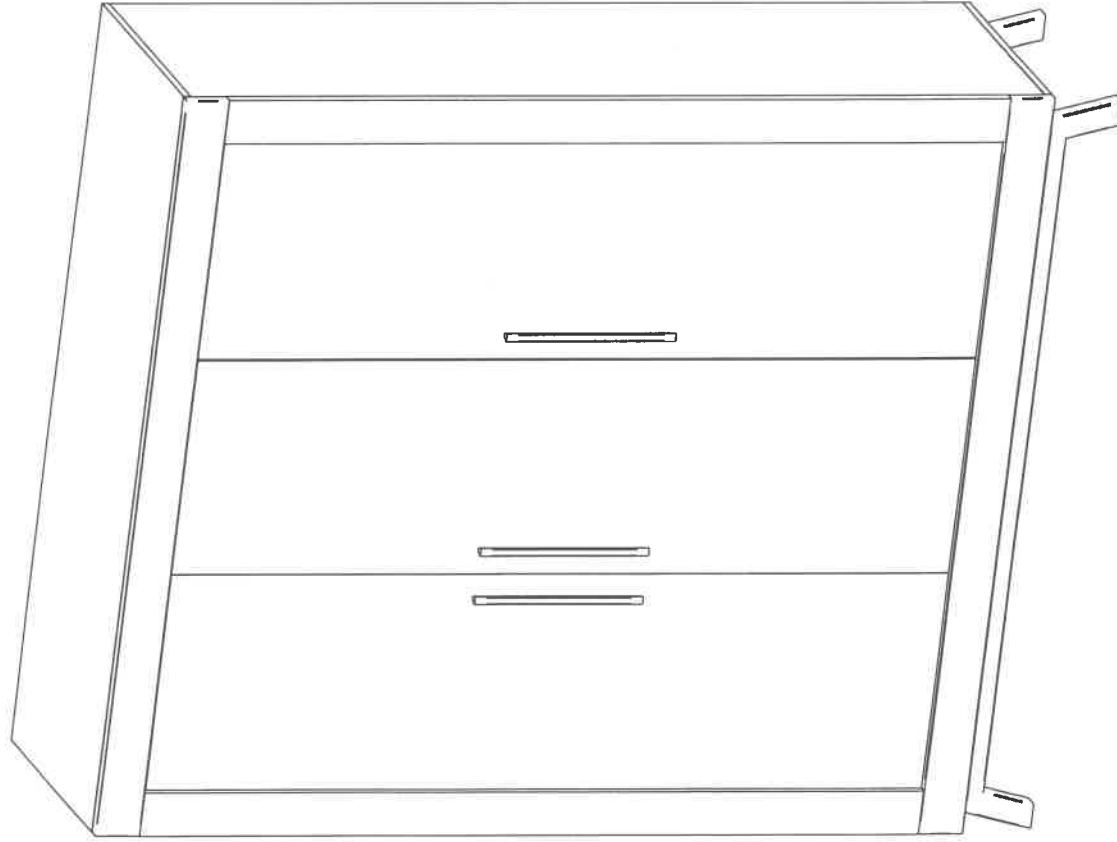

Schardt GmbH & Co. KG  
Am Riegel 15  
96268 Mitwitz  
Tel. 09266/9907-0  
Fax 09266/9907-77  
E-Mail: [info@schardt.com](mailto:info@schardt.com)

