

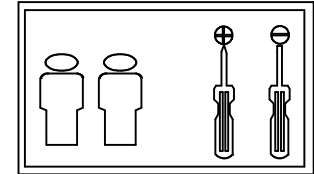









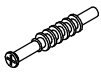



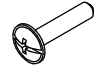

Inhalt - Contents - Contenu - Inhoud - contenuto -contenido-conteúdo - περιεχόμενο

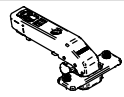

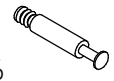
# Miami 06 795

Schrank 2 Türen

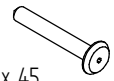
Beschlagbeutel:

A 	B  15 ohne Rand	D  3 x 16	E 
16 x	16 x	4 x	20 x
F 	G 	H  M4 x 20	I  7 mm
8 x	2 x	4 x	6 x
J 	K 	L 	M  M6
6 x	2 x	4 x	4 x
N 	O  448 mm Holz Griff	P 	R  M6 x 45
4 x	2 x	1 x	4 x
S 			
4 x			

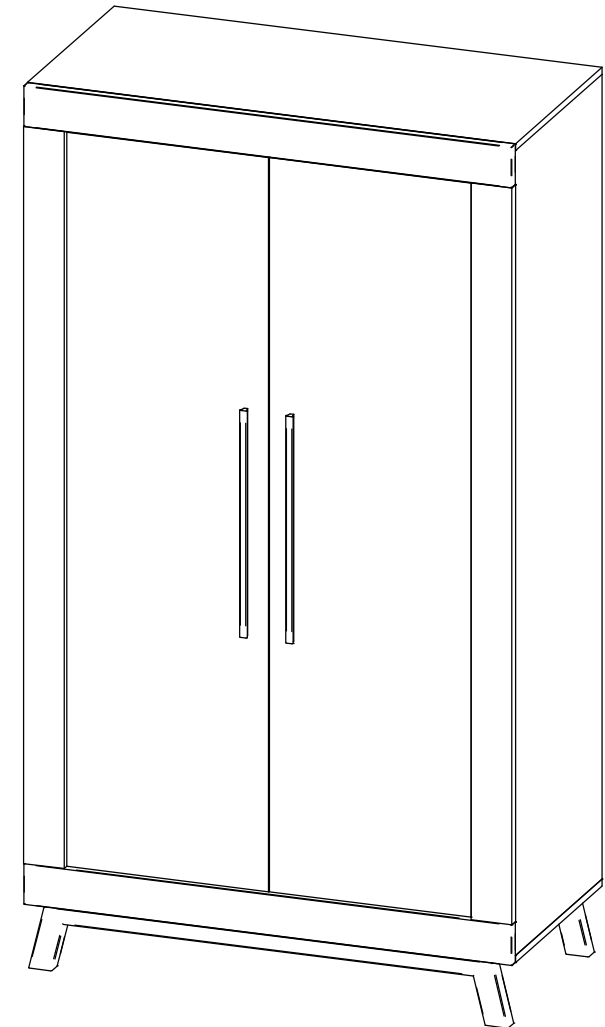
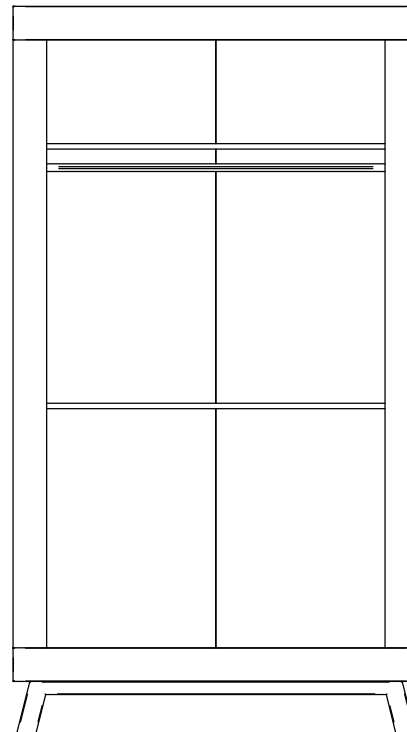

Inhalt - Contents - Contenu - Inhoud - contenuto - contenido-conteúdo - περιεχόμενο

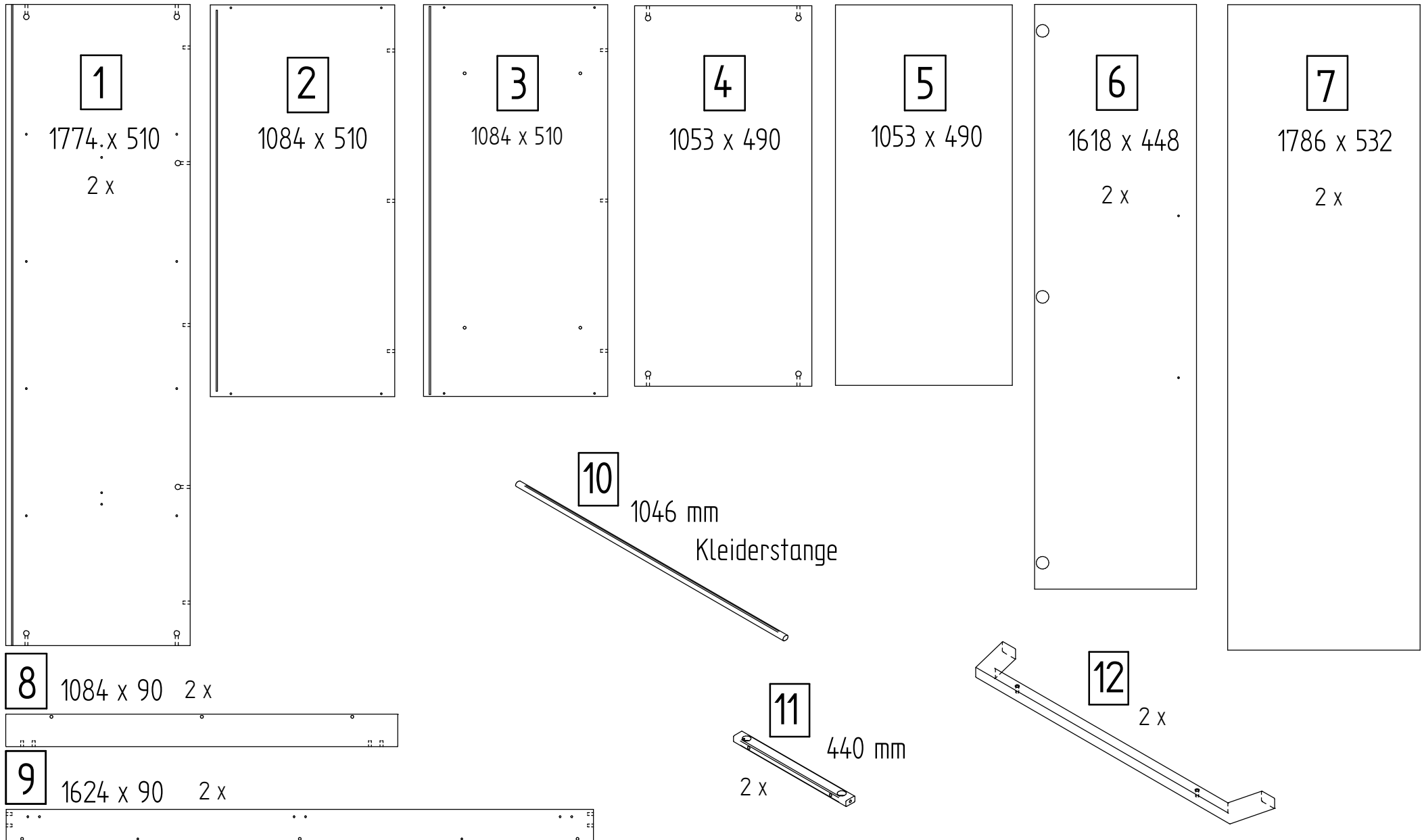

# Vormontage:

Vor weiterer Montage der Beschläge den Leim 30 min abbinden lassen.  
 Before further installation of the fittings the glue thicken for 30 minutes.  
 Avant l'installation ultérieure des raccords, la colle épaissir pendant 30 minutes.  
 Voor verdere montage van het beslag de lijm dik gedurende 30 minuten.  
 Prima ulteriore installazione dei raccordi addensare la colla per 30 minuti.  
 Antes de la instalación posterior de los accesorios de la cola espesar durante 30 minutos.  
 Antes da instalação posterior dos acessórios a engrossar cola durante 30 minutos.  
 Πριν από την περαιτέρω εγκατάσταση των εξαρτημάτων πικνύνσει η κόλλα για 30 λεπτά.

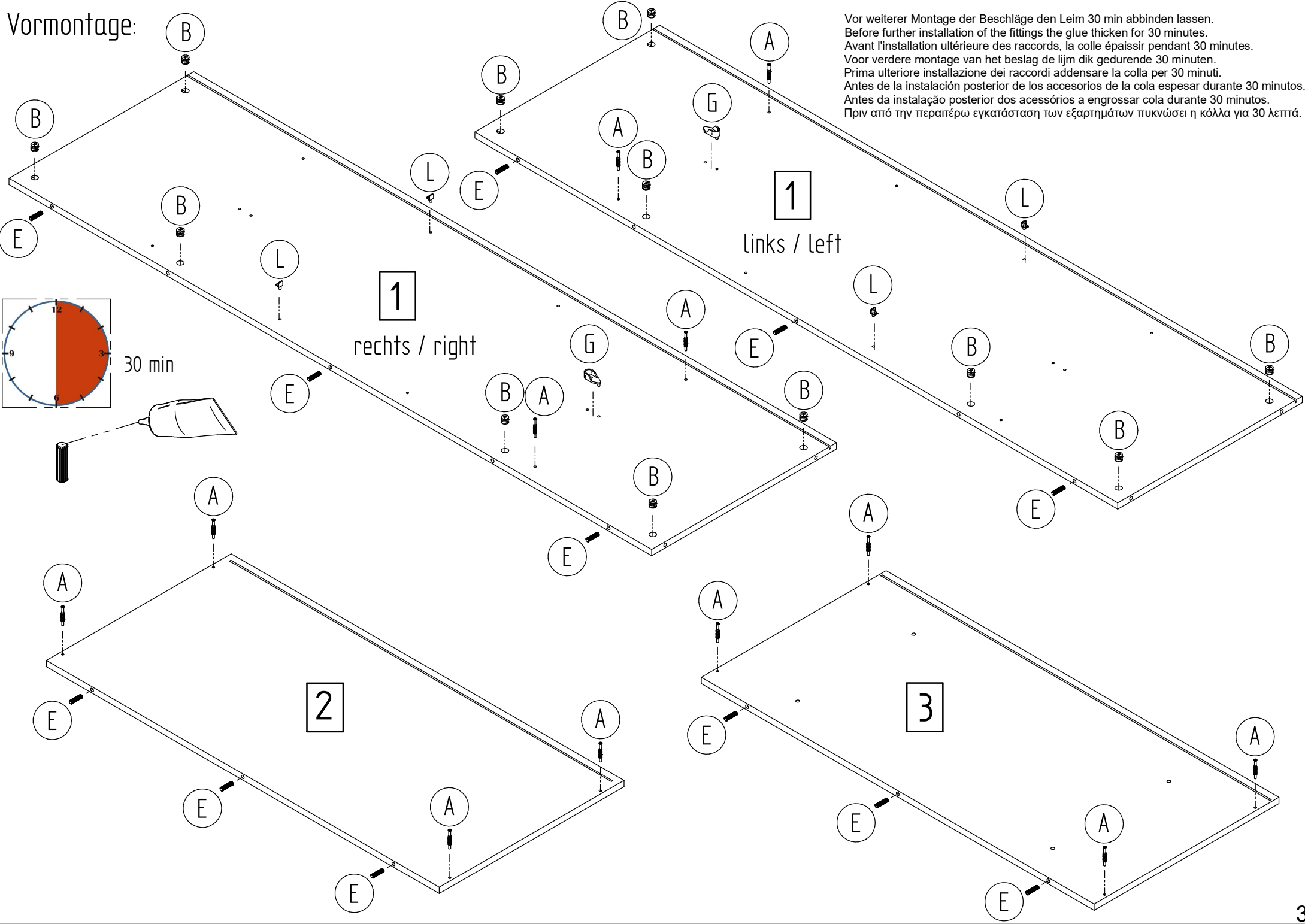

# Vormontage:

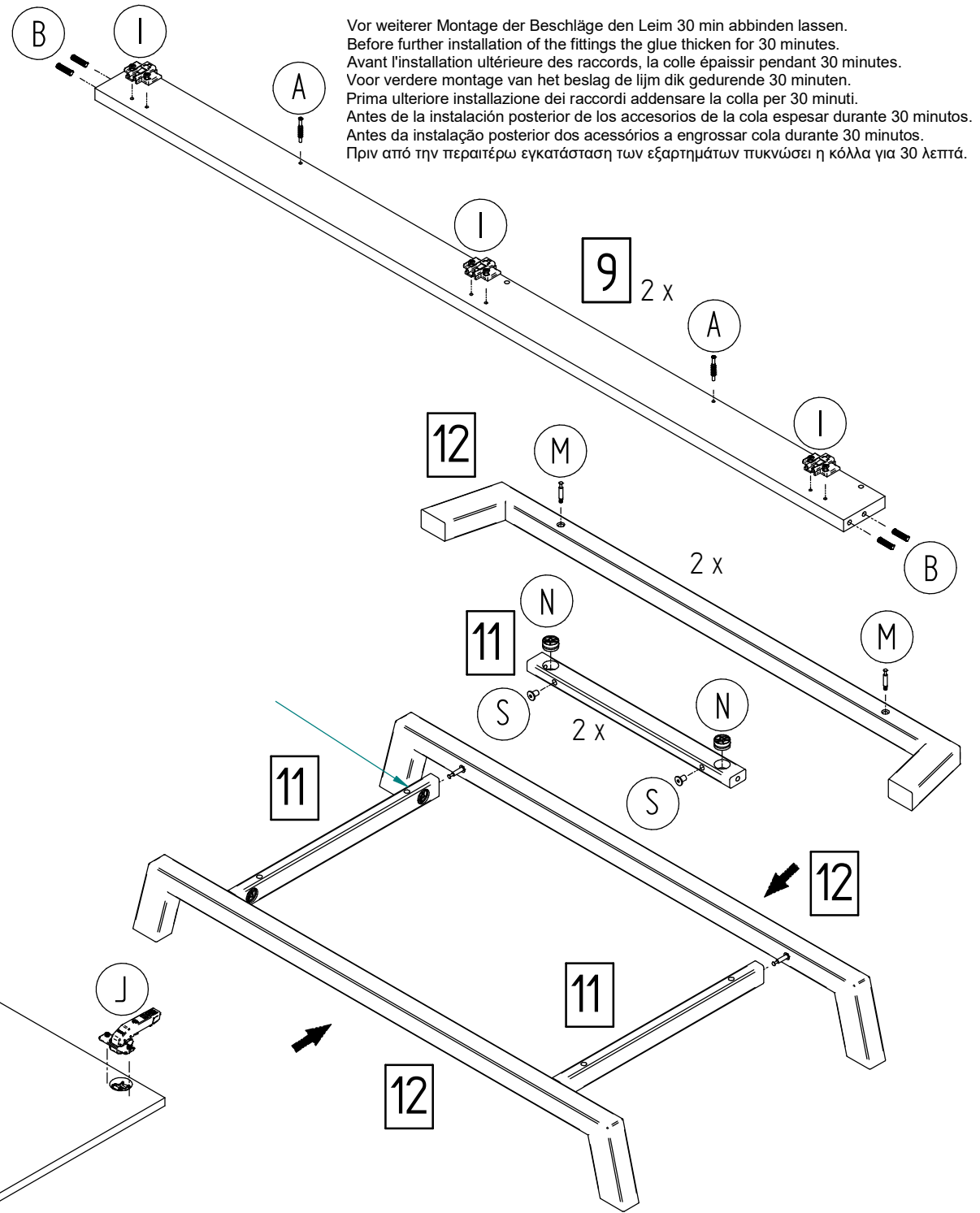
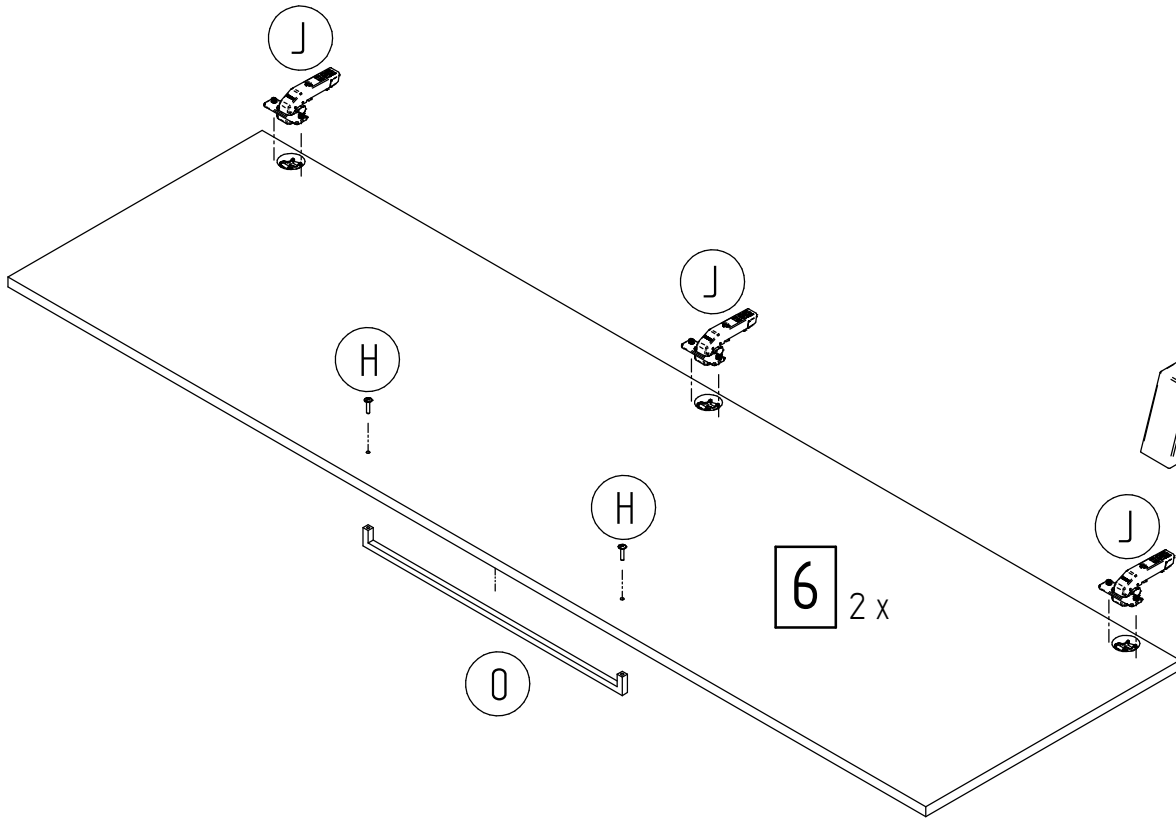
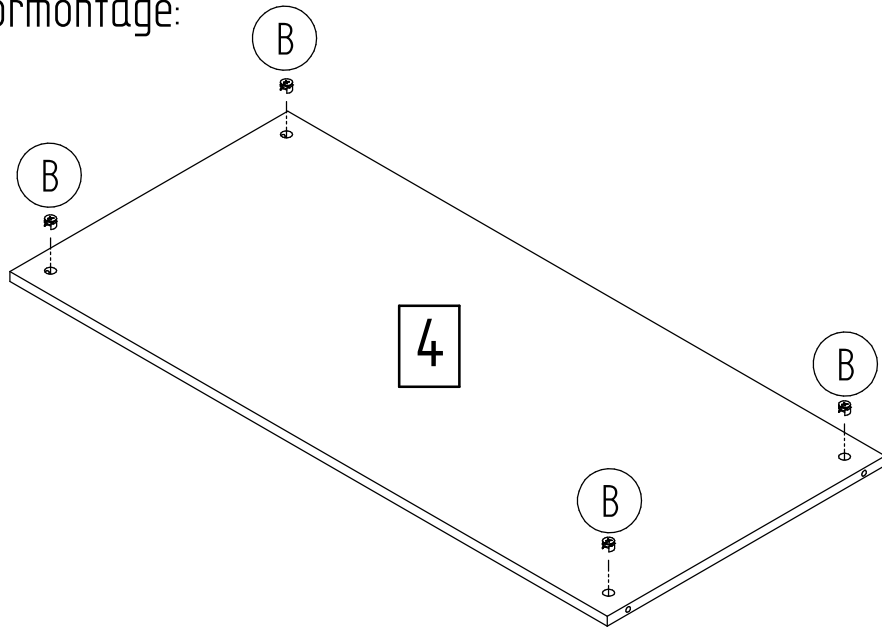

Vor weiterer Montage der Beschläge den Leim 30 min abbinden lassen.  
Before further installation of the fittings the glue thicken for 30 minutes.  
Avant l'installation ultérieure des raccords, la colle épaissir pendant 30 minutes.  
Voor verdere montage van het beslag de lijm dik gedurende 30 minuten.  
Prima ulteriore installazione dei raccordi addensare la colla per 30 minuti.  
Antes de la instalación posterior de los accesorios de la cola espesar durante 30 minutos.  
Antes da instalação posterior dos acessórios a engrossar cola durante 30 minutos.  
Πριν από την περαιτέρω εγκατάσταση των εξαρτημάτων πυκνώσει η κόλλα για 30 λεπτά.

Zusammenbau:

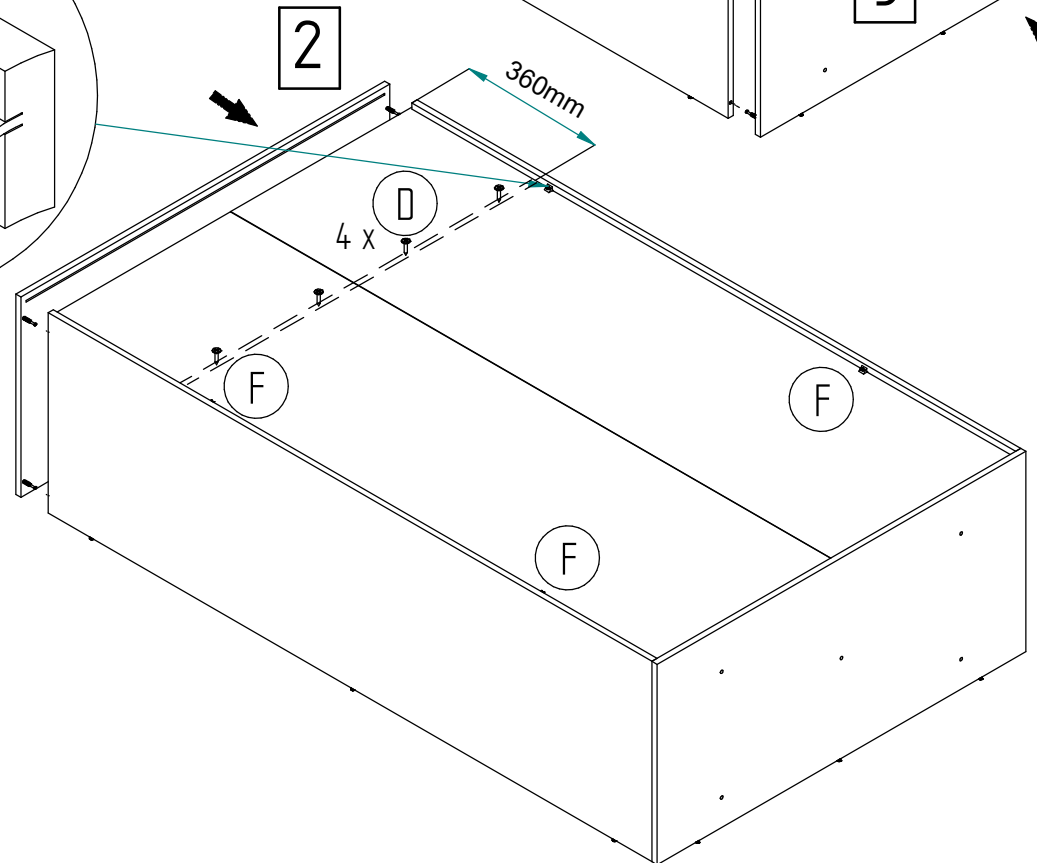
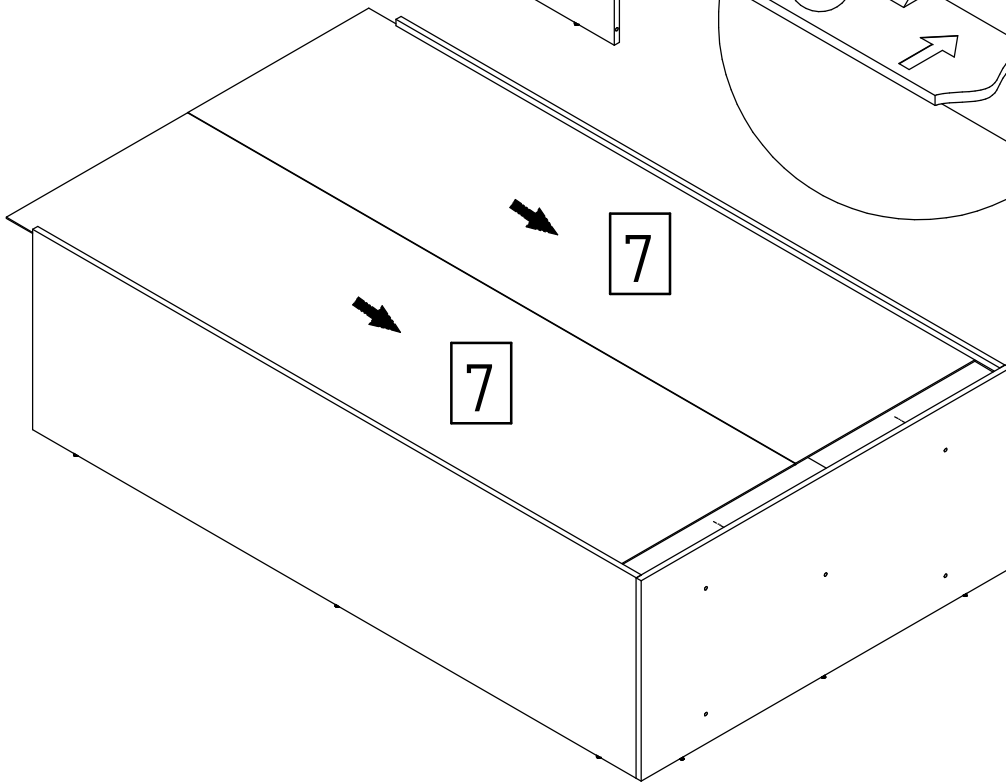
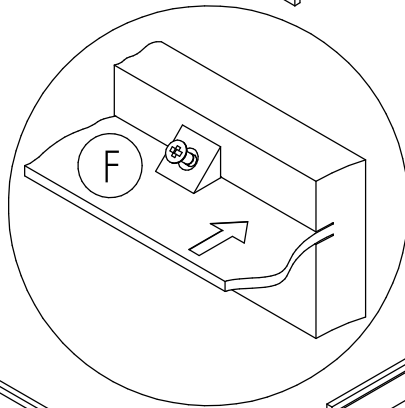
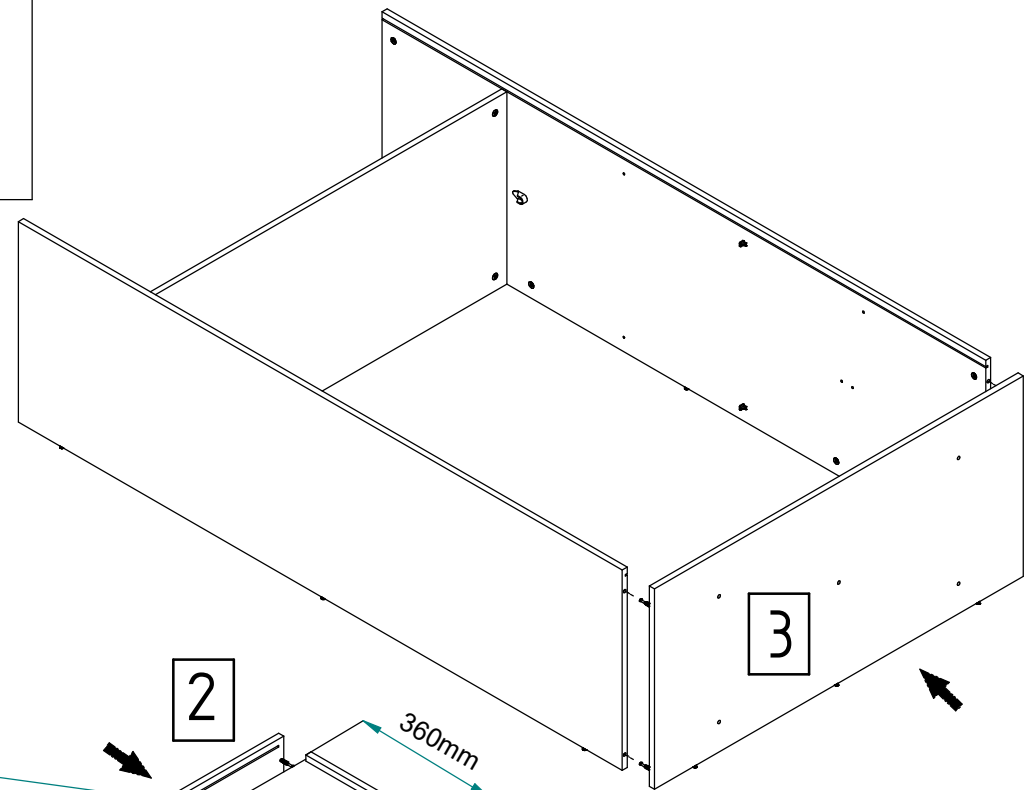
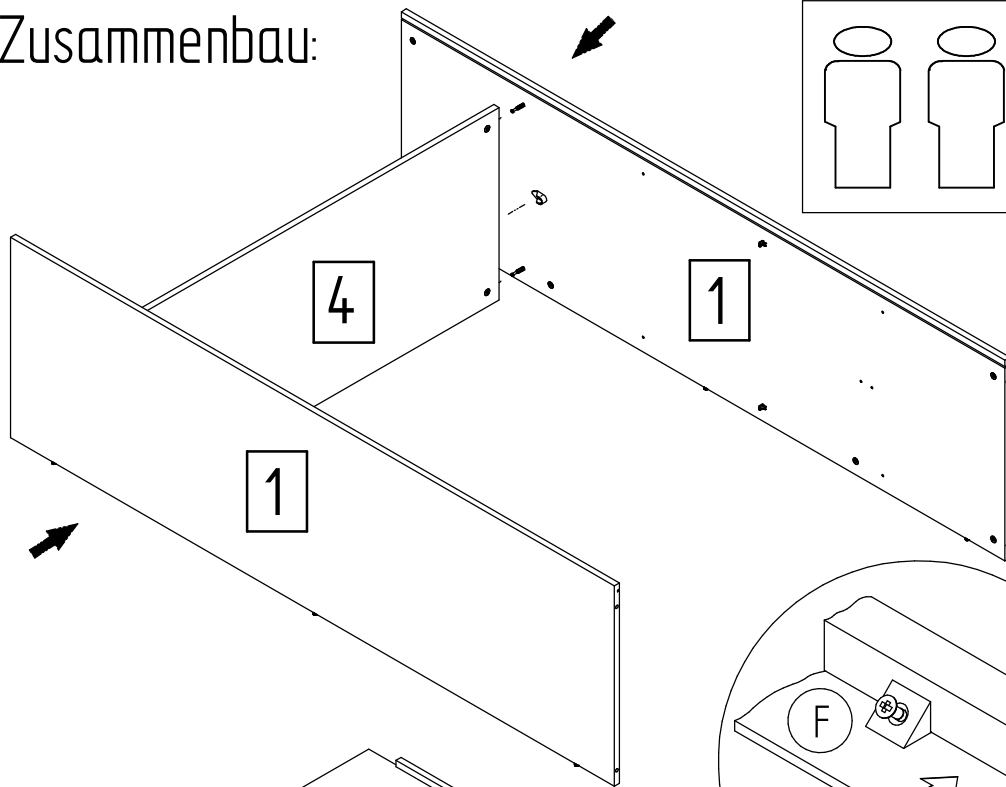
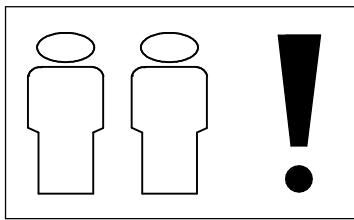

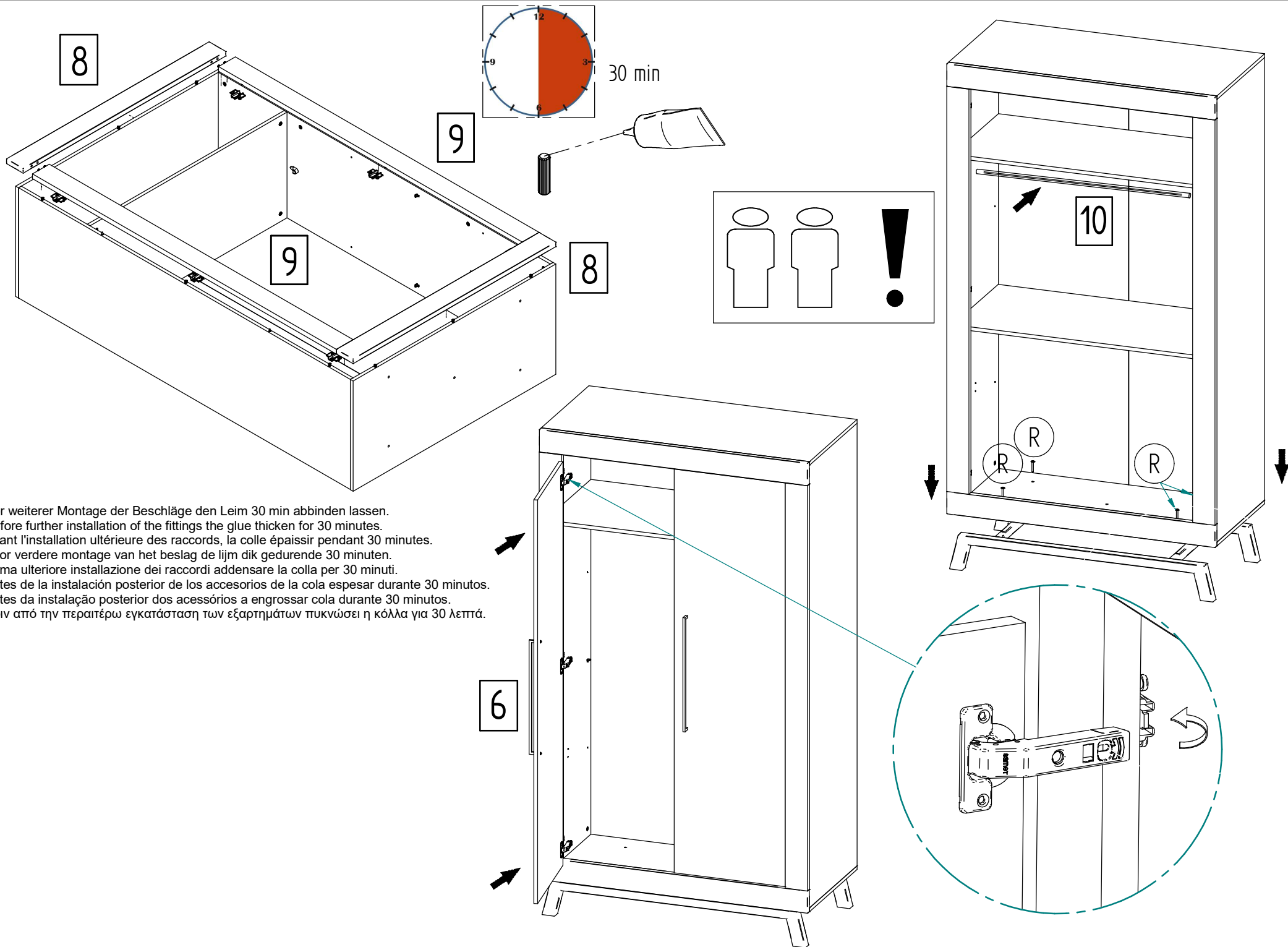

8

9

9

8

10

6

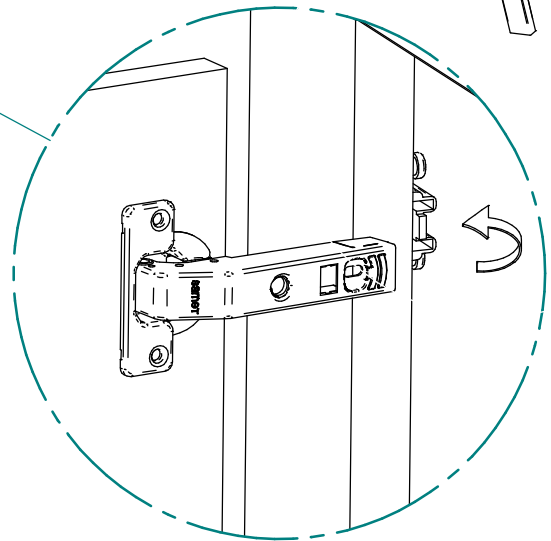
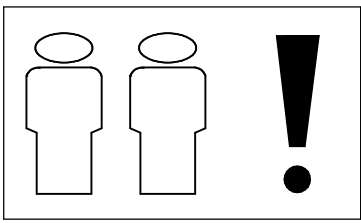
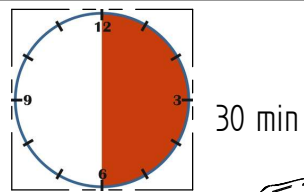

Vor weiterer Montage der Beschläge den Leim 30 min abbinden lassen.  
 Before further installation of the fittings the glue thicken for 30 minutes.  
 Avant l'installation ultérieure des raccords, la colle épaissir pendant 30 minutes.  
 Voor verdere montage van het beslag de lijm dik gedurende 30 minuten.  
 Prima ulteriore installazione dei raccordi addensare la colla per 30 minuti.  
 Antes de la instalación posterior de los accesorios de la cola espesar durante 30 minutos.  
 Antes da instalação posterior dos acessórios a engrossar cola durante 30 minutos.  
 Πριν από την περαιτέρω εγκατάσταση των εξαρτημάτων πικνώσει η κόλλα για 30 λεπτά.

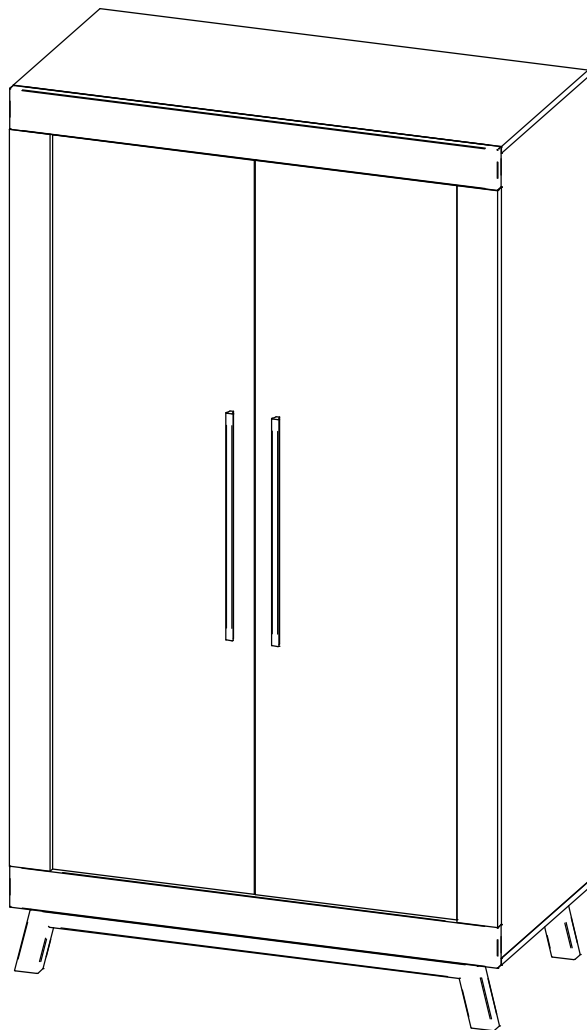

... weitere Infos über unsere Produkte unter

[www.schardt.com](http://www.schardt.com)

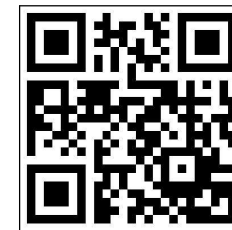

**Schardt GmbH & Co. KG**  
Am Riegel 15  
96268 Mitwitz  
Tel. 09266/9907-0  
Fax 09266/9907-77  
E-Mail: [info@schardt.com](mailto:info@schardt.com)