

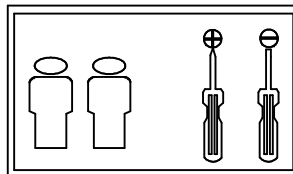









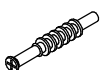

Inhalt - Contents - Contenu - Inhoud - contenuto -contenido-conteúdo - περιεχόμενο

# Eco Plus 06 566

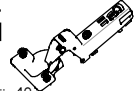
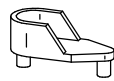
Schrank

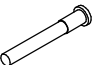
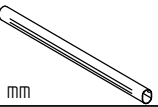

Beschlagbeutel:

A  16 x	B  ohne Rand 16 x	C  8 x 30 20 x
D  3 x 16 5 x	E  4 x	F  Invo H7mm 6 x
G  krö. 18mm 6 x	H  2 x	J  2 x
K  M4 x 20 4 x	L  12 x	M  6,3 x50 1 x
N  800 mm 1 x	P  2 x	

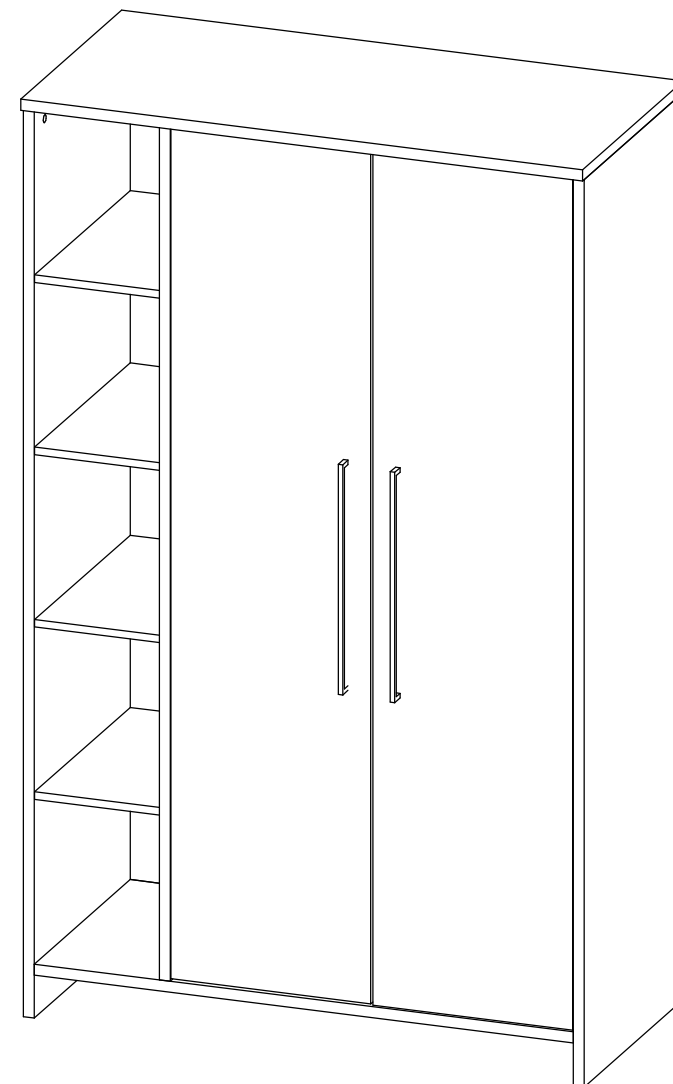
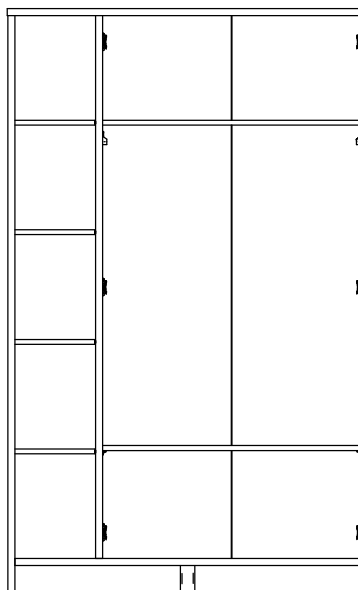

Inhalt - Contents - Contenu - Inhoud - contenuto -contenido-conteúdo - περιεχόμενο

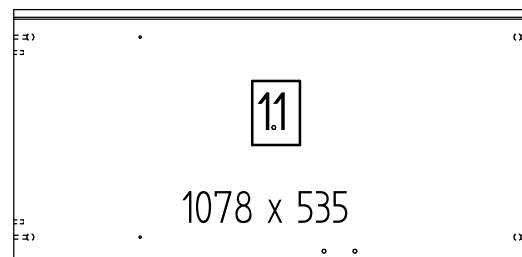
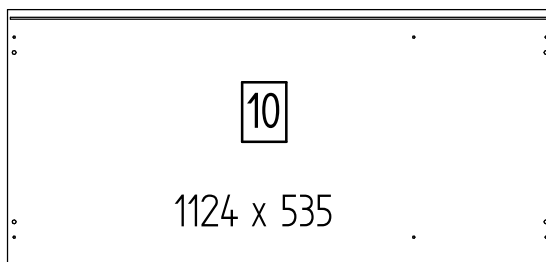
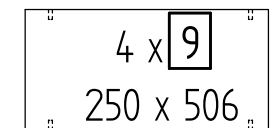
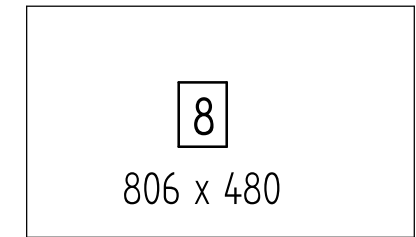
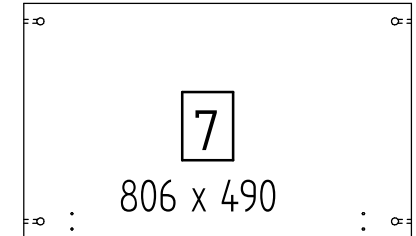
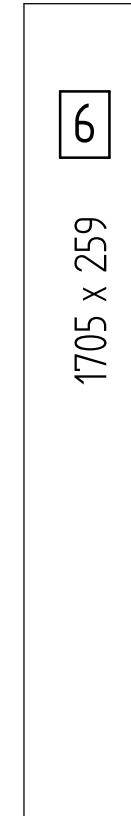
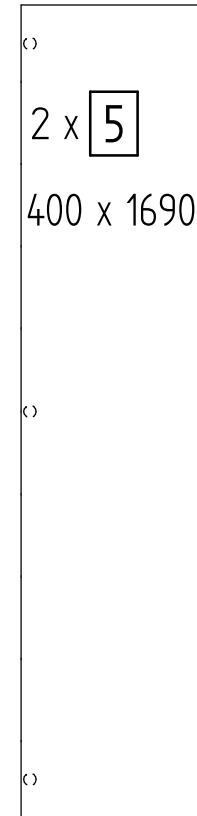
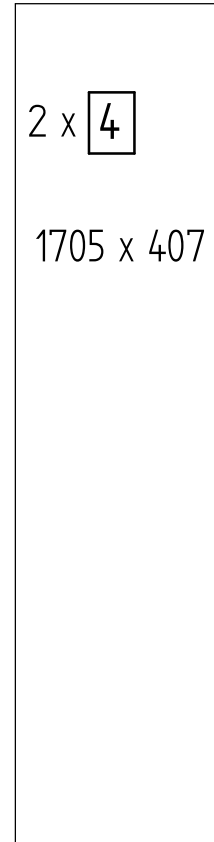
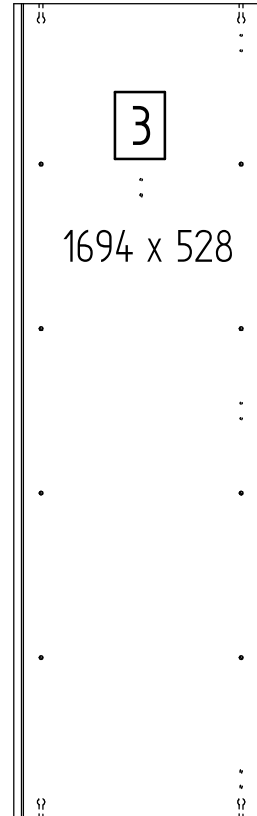
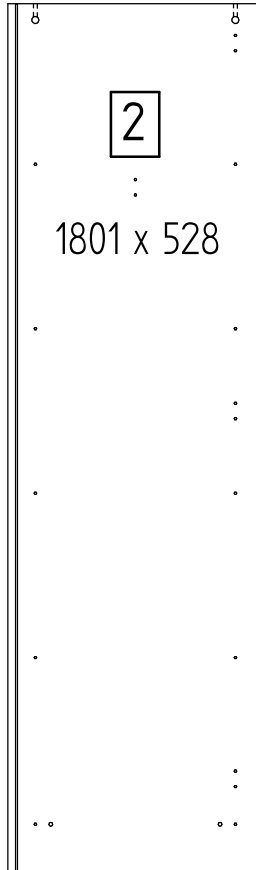
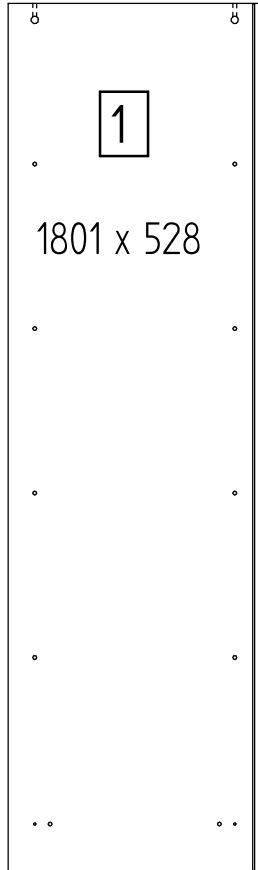

# Vormontage:

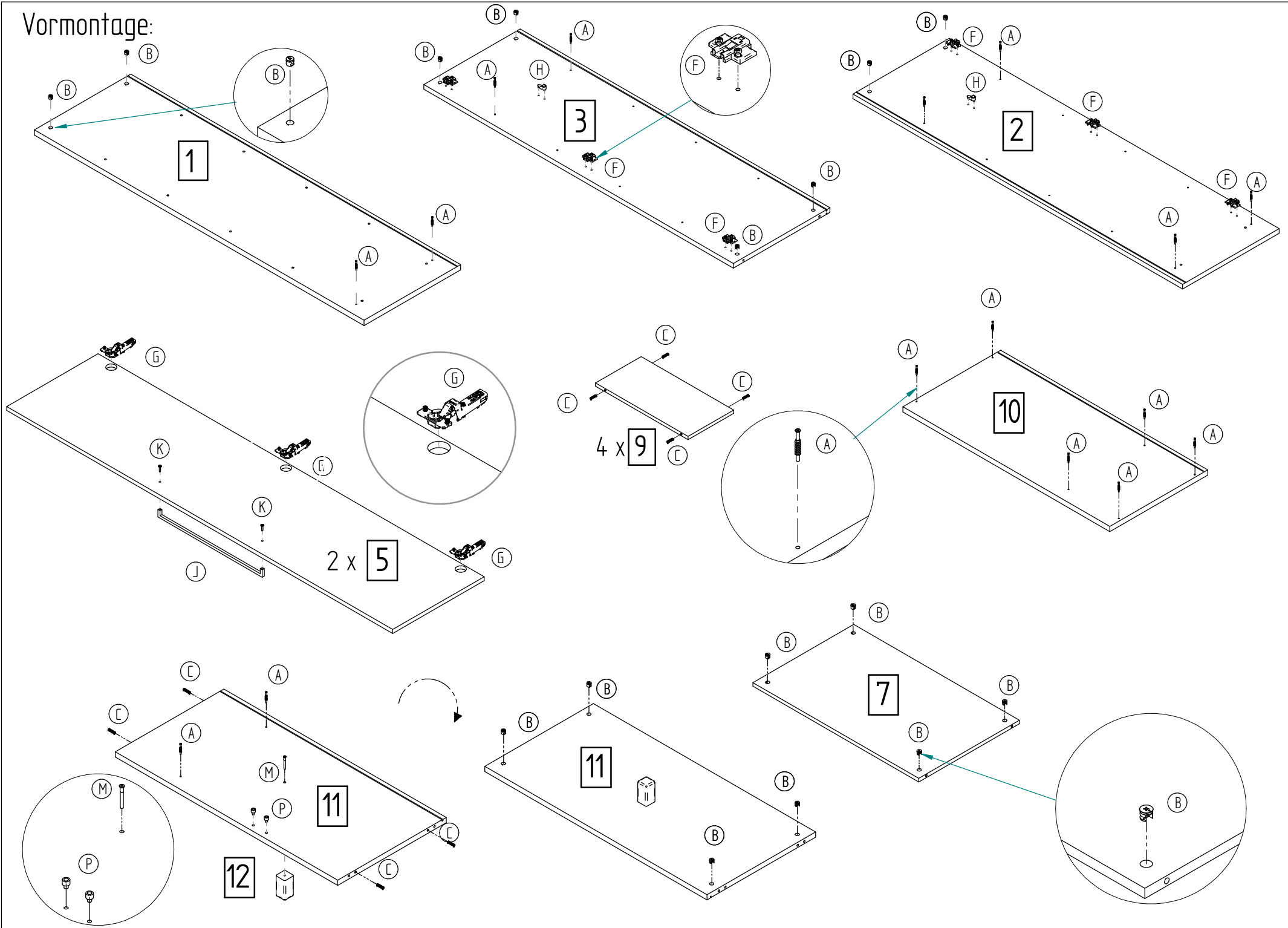

Vormontage:

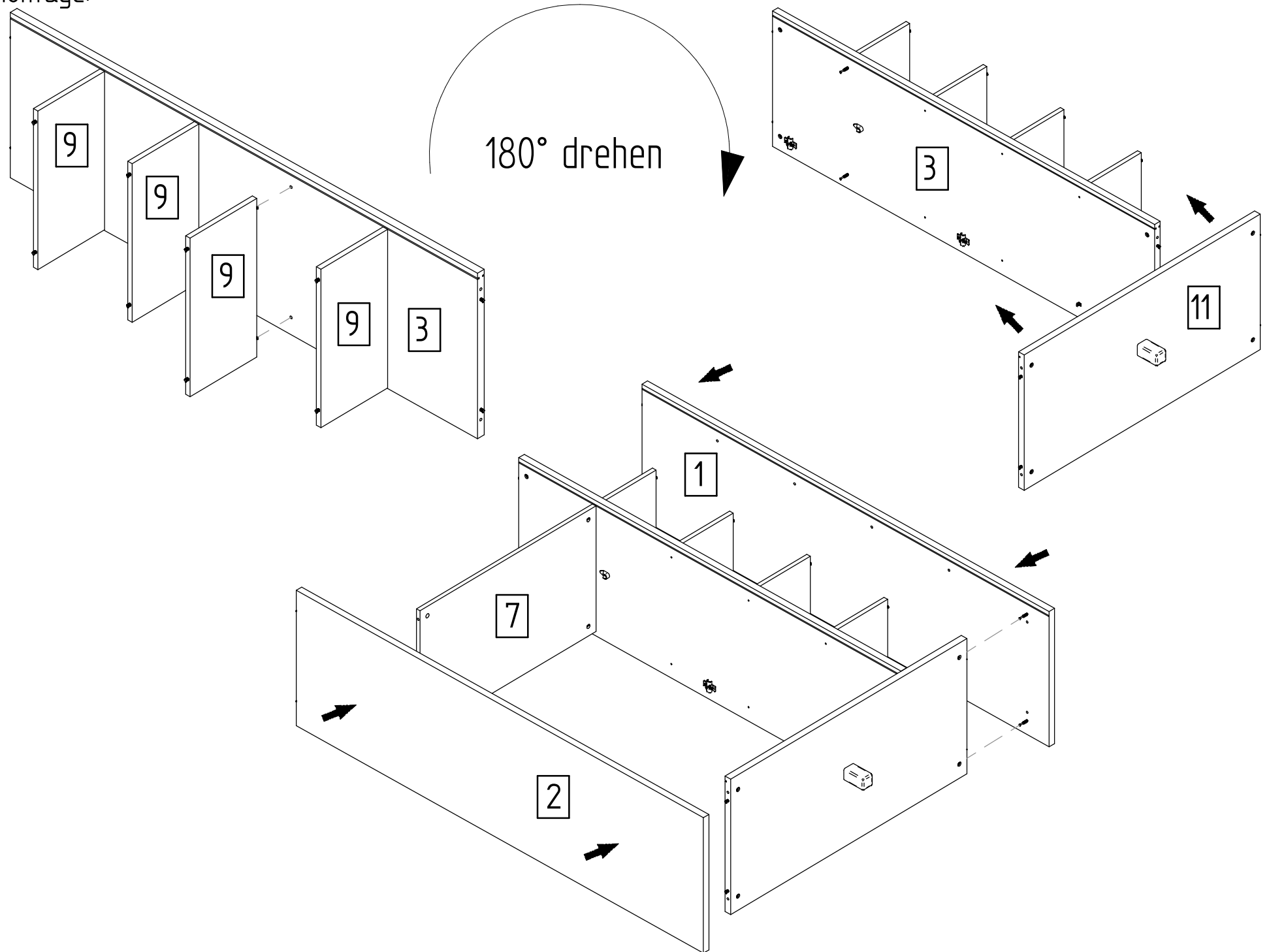

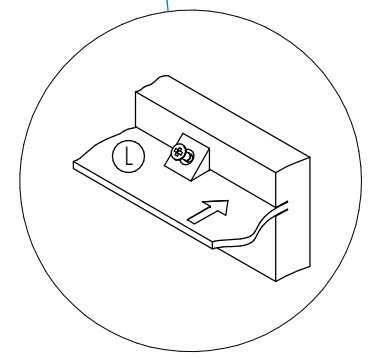
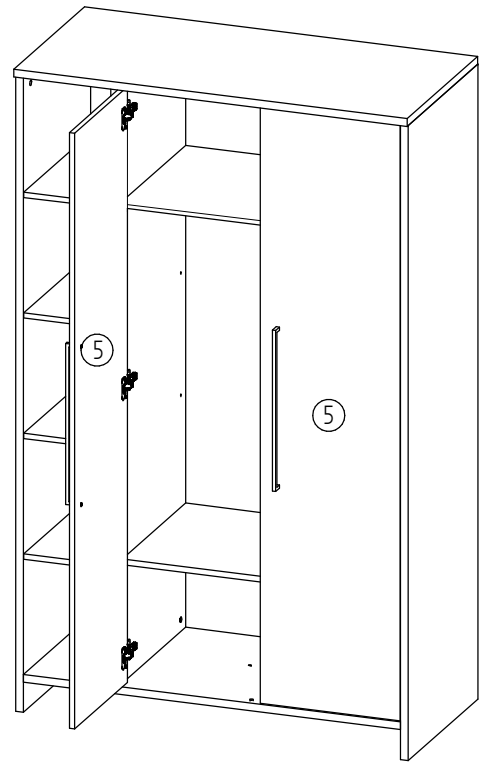
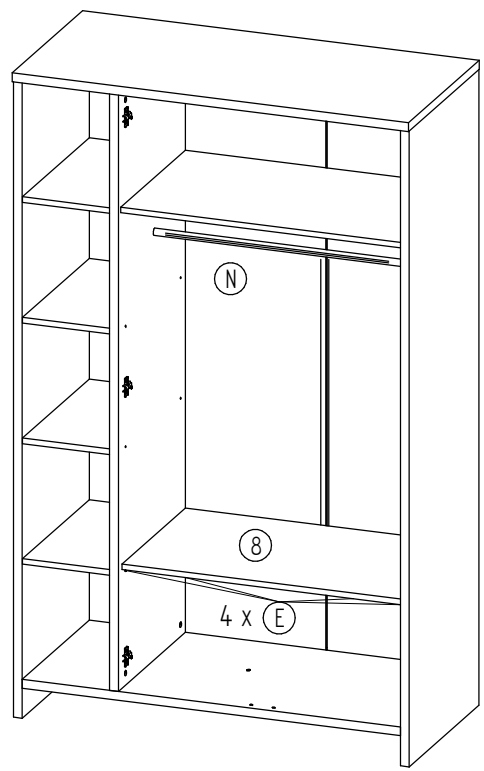
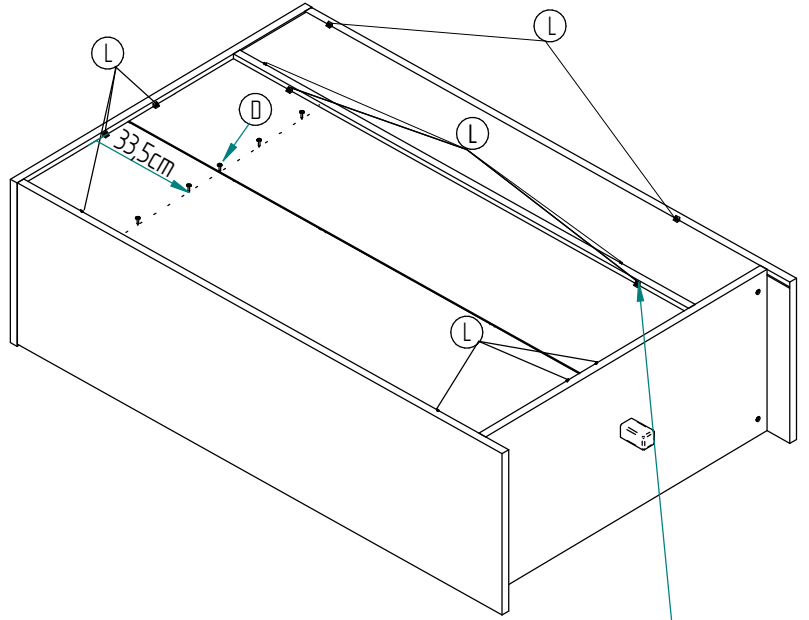
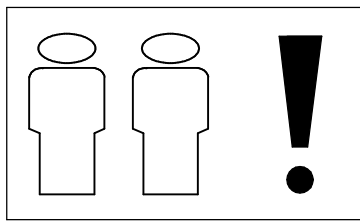
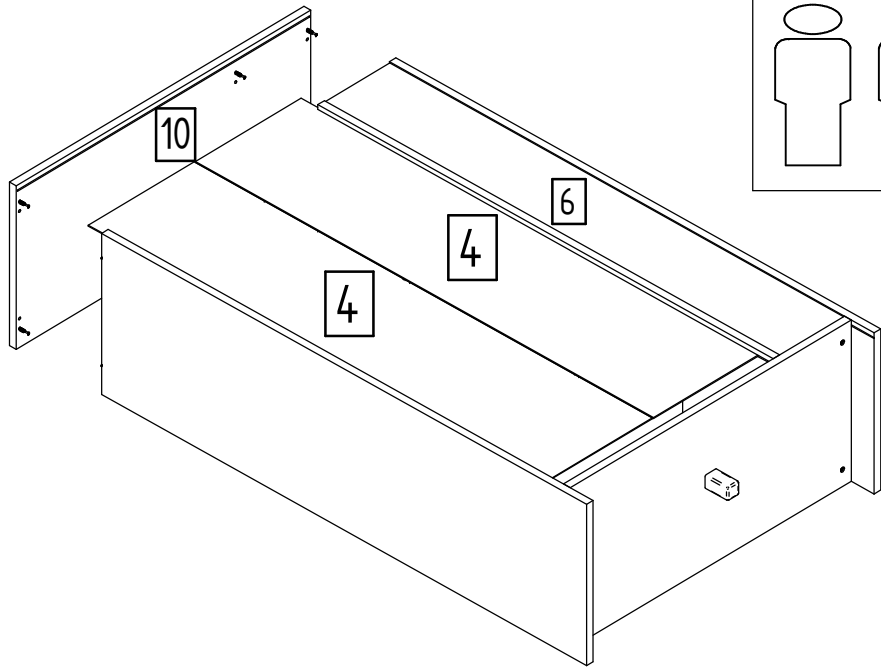

... weitere Infos über unsere Produkte unter

[www.schardt.com](http://www.schardt.com)

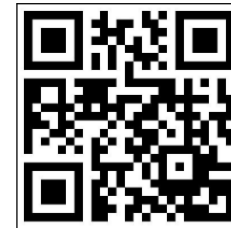

**Schardt GmbH & Co. KG**  
**Am Riegel 15**  
**96268 Mitwitz**  
**Tel. 09266/9907-0**  
**Fax 09266/9907-77**  
**E-Mail: [info@schardt.com](mailto:info@schardt.com)**