

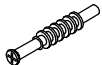









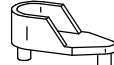

Inhalt - Contents - Contenu - Inhoud - contenuto - contenido-conteúdo - περιεχόμενο

Eco Silber 06 551 33

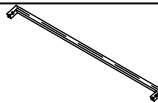
Schrank

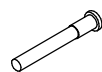
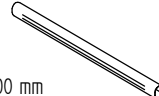
Beschlagbeutel:

A  16 x	B  15 ohne Rand 20 x	C  8 x 30 4 x
D  3 x 16 14 x	E  16 x	F  Invo H7mm 9 x
G  krö. 18 mm 9 x	H  2 x	I  2 x
J  3 x	K  M4 x 25 6 x	L  10 x
M  7 x 50 1 x	N  800 mm 1 x	O  4 x
P  2 x		

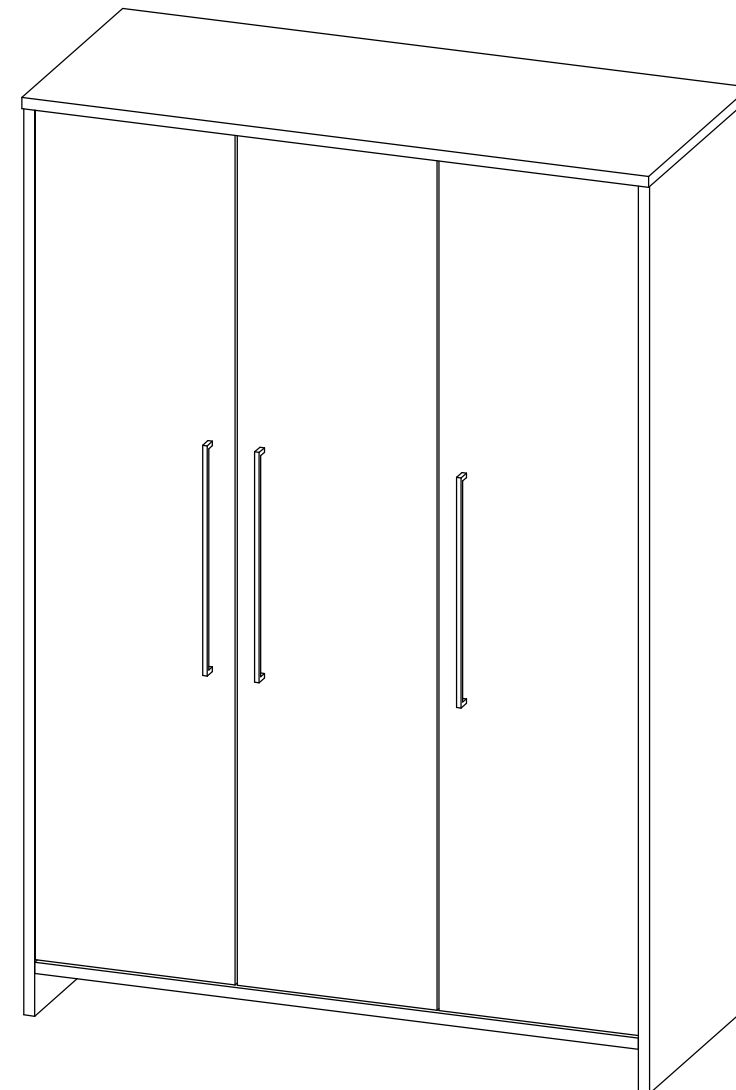
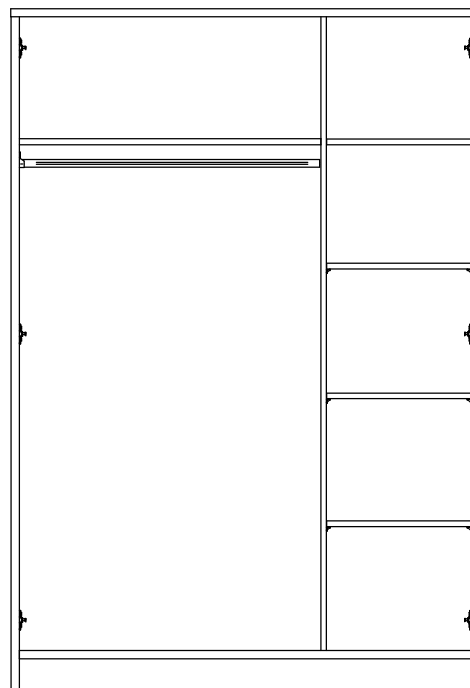
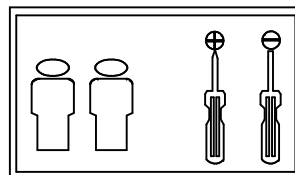

Inhalt - Contents - Contenu - Inhoud - contenuto -contenido-conteúdo - περιεχόμενο

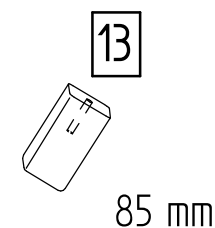
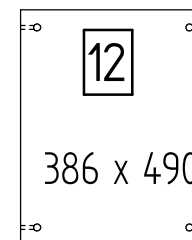
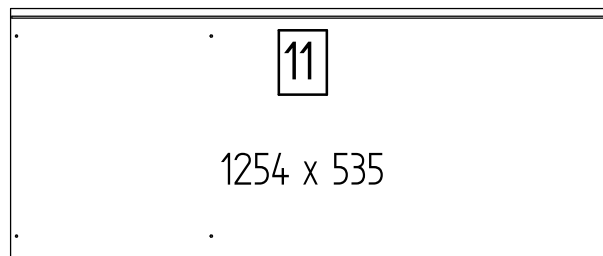
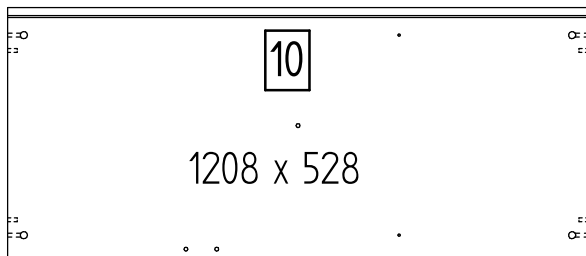
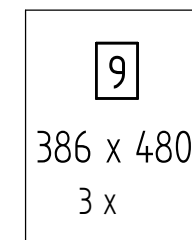
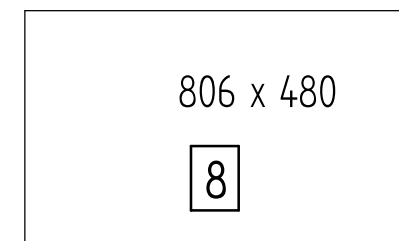
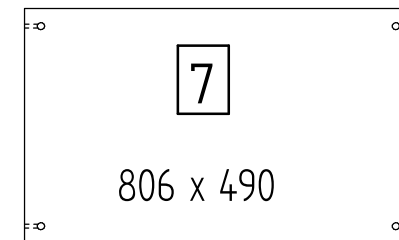
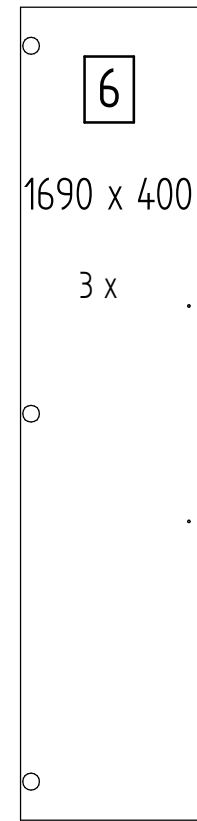
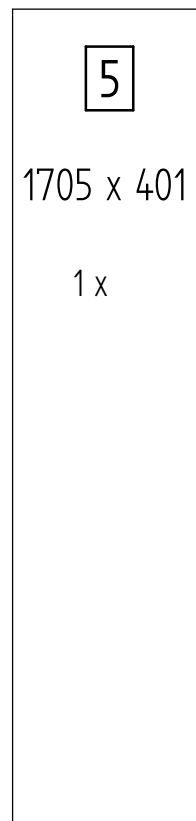
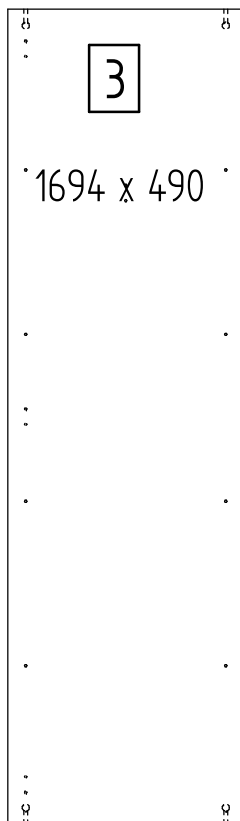
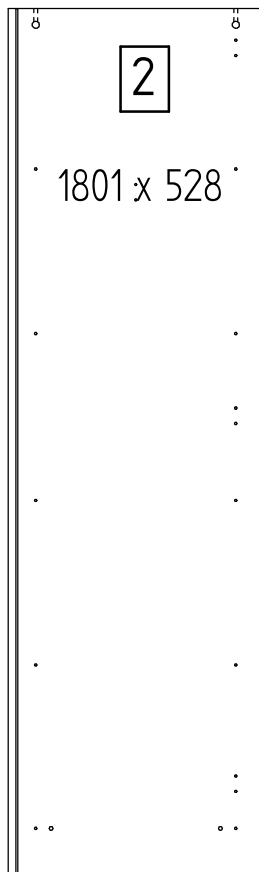
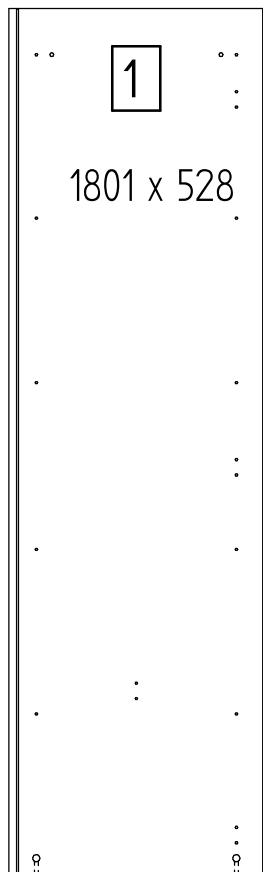

Vormontage:

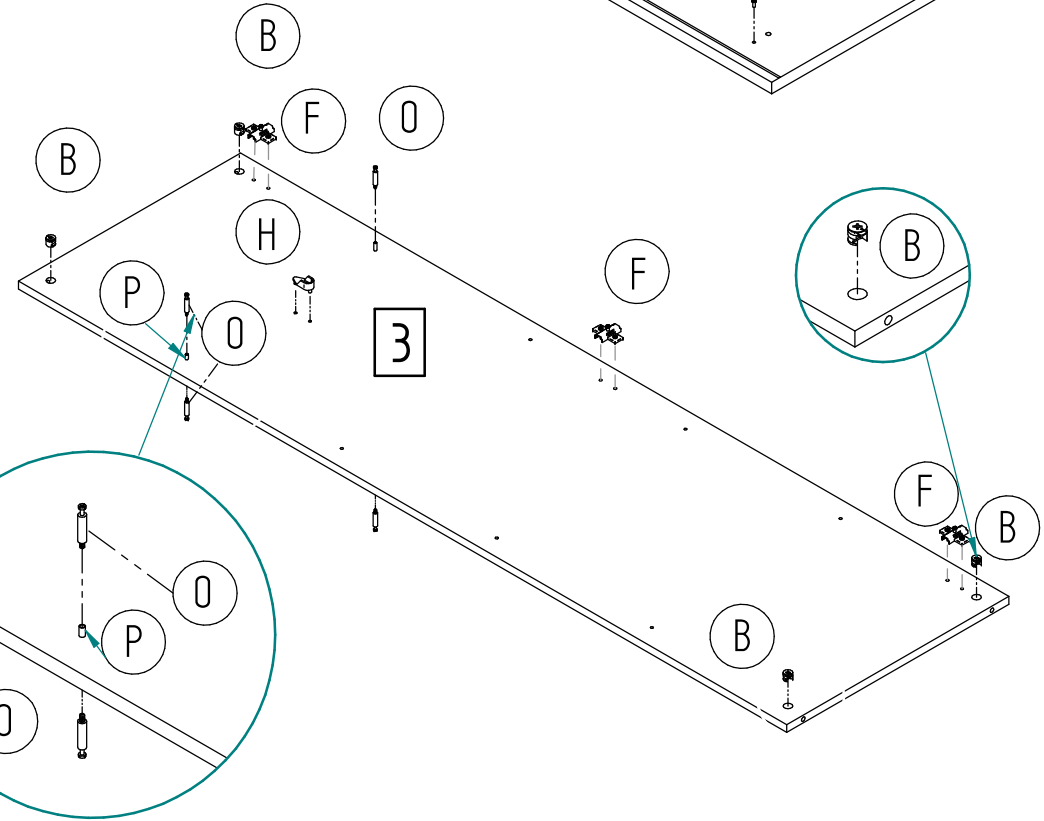
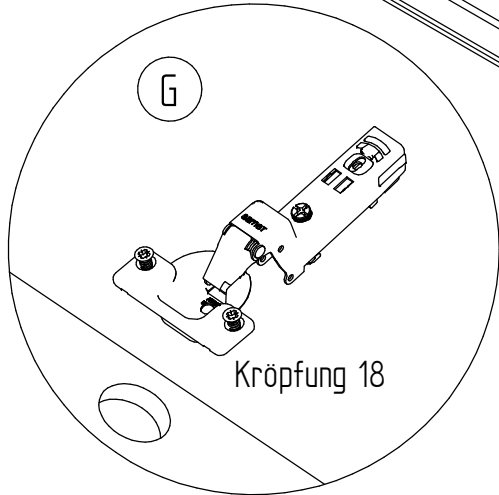
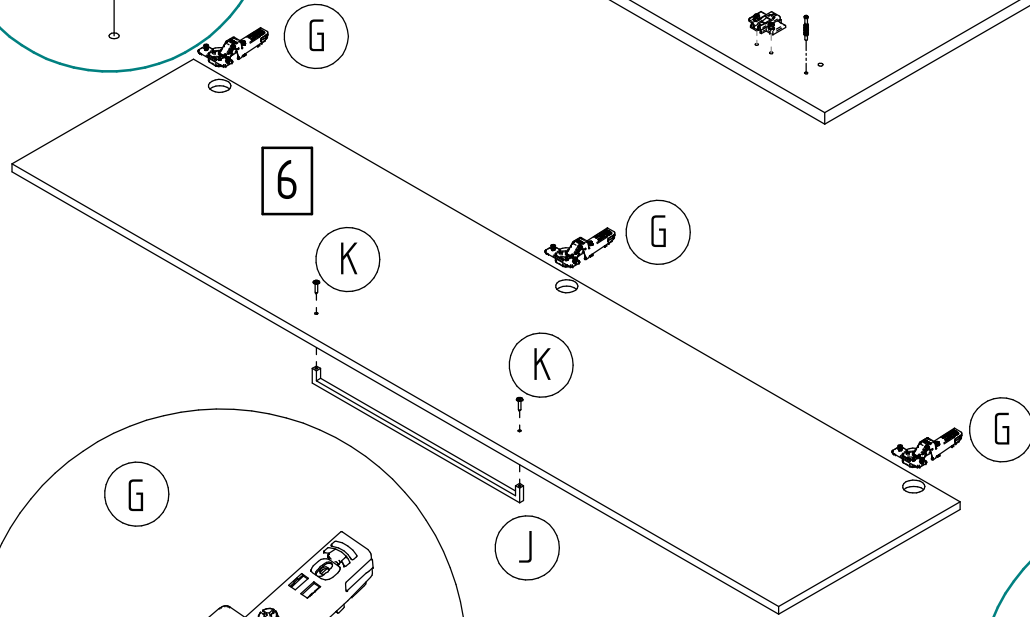
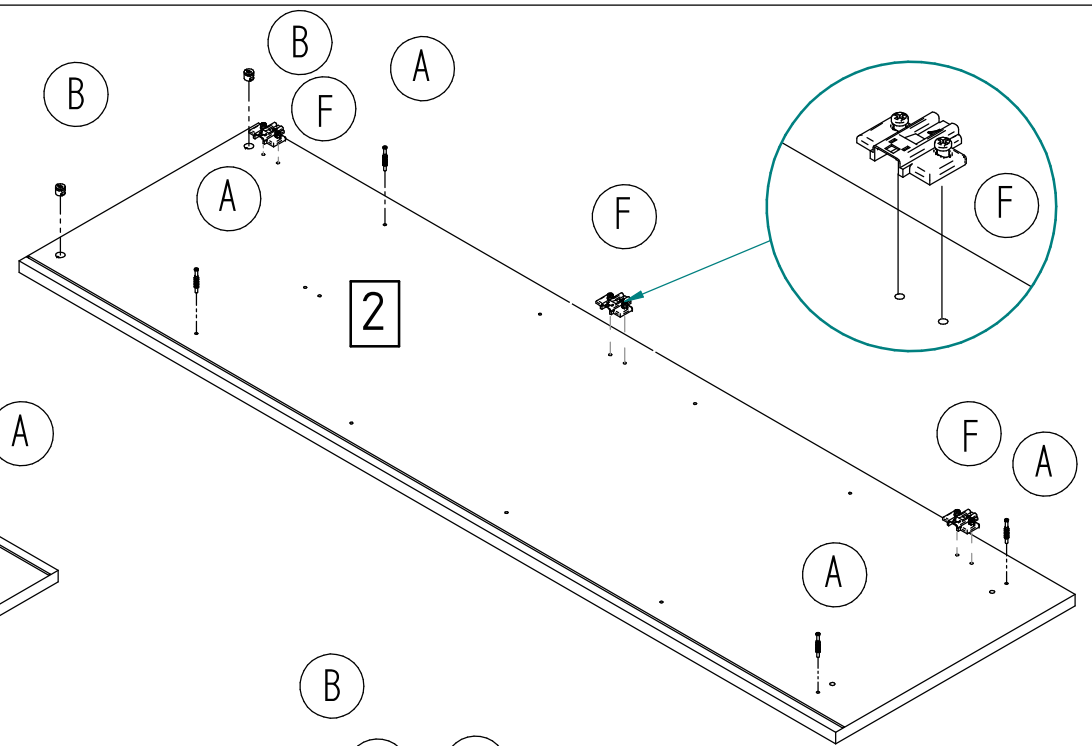
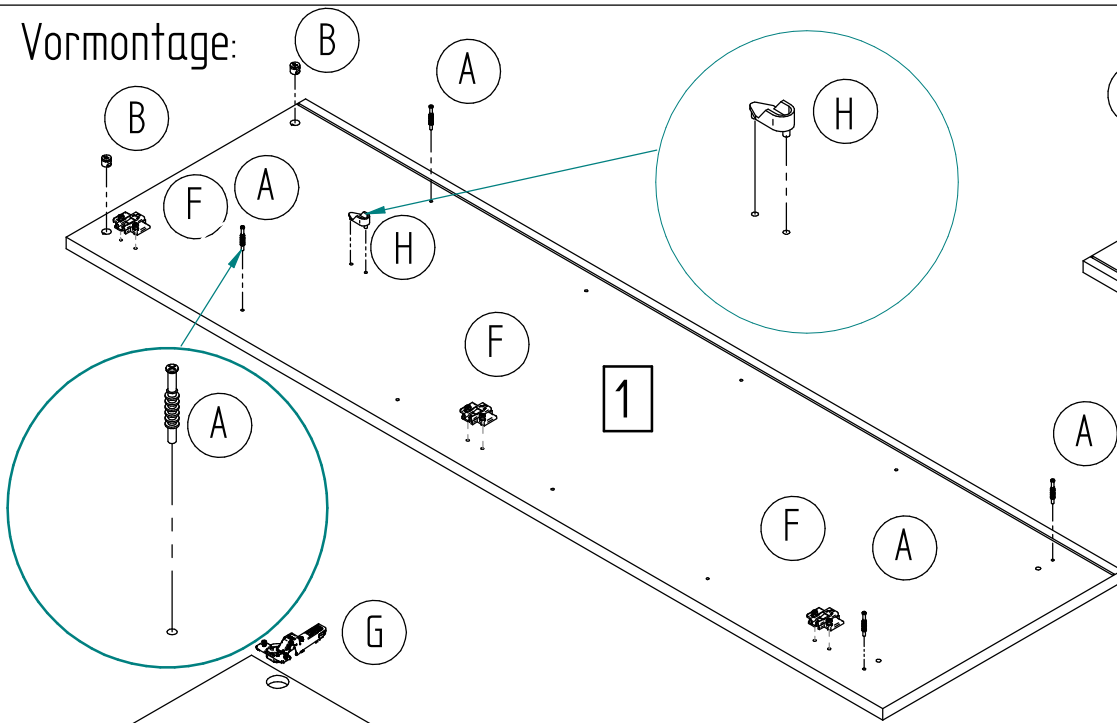

Achtung! Vor Eindrehen der Exzenterbolzen 0 Gewindehülse eindrücken 2

Vormontage:

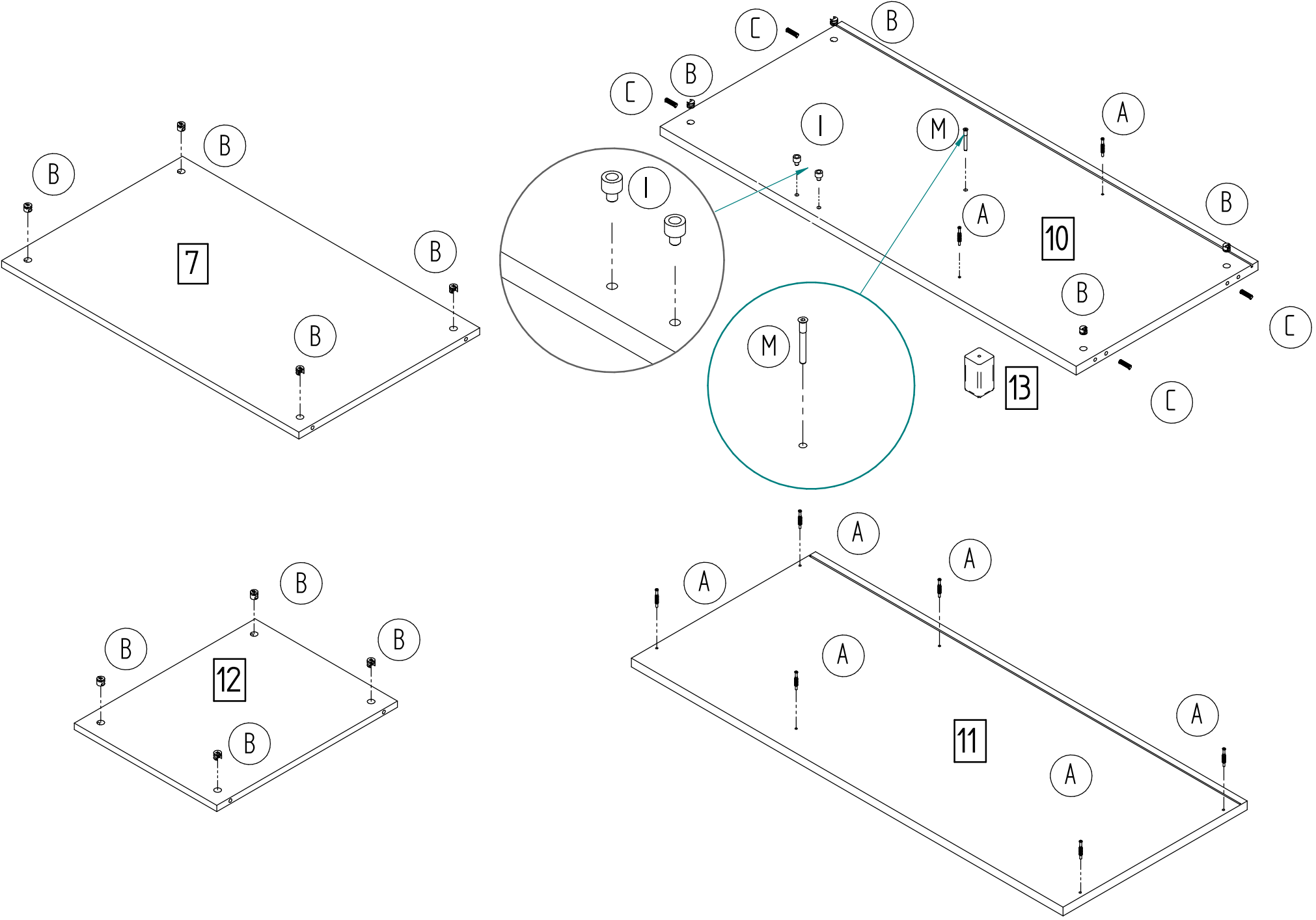

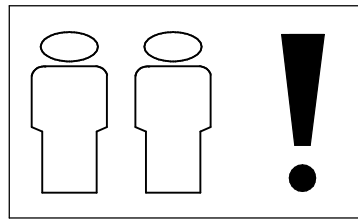
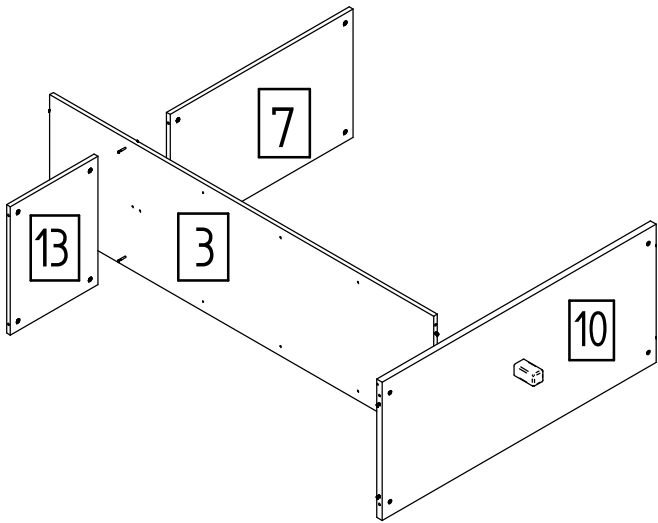

Zum Einschieben der Rückwände den Schrank aufrichten, zur weiteren Montage der Rückwandschrauben den Schrank wieder legen.

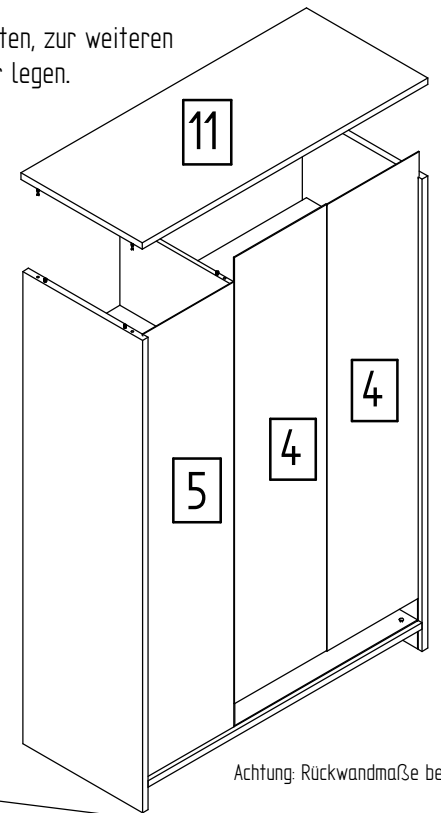
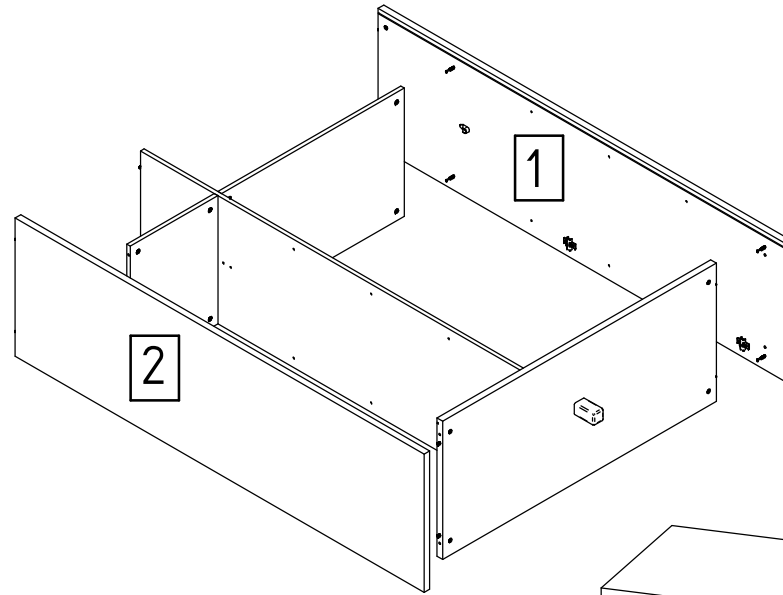

Achtung: Rückwandmaße beachten

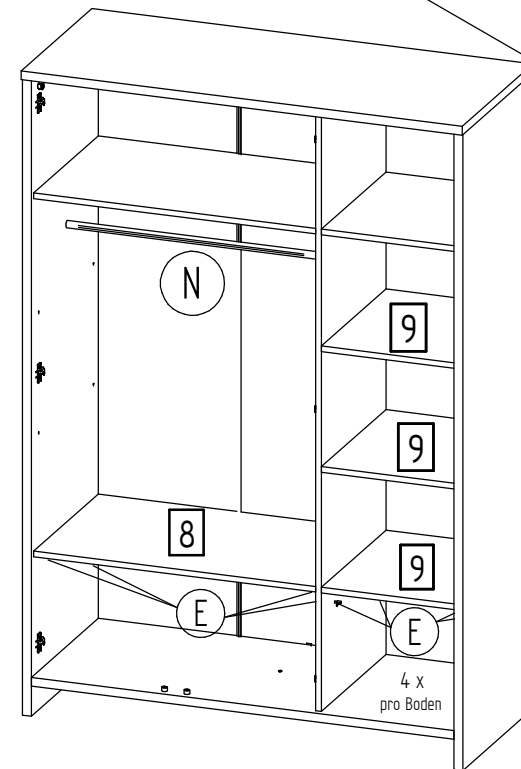
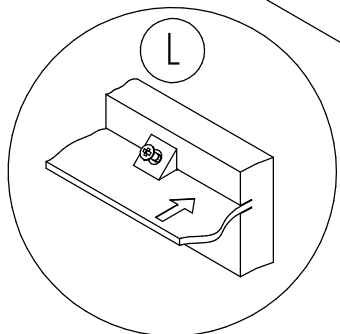
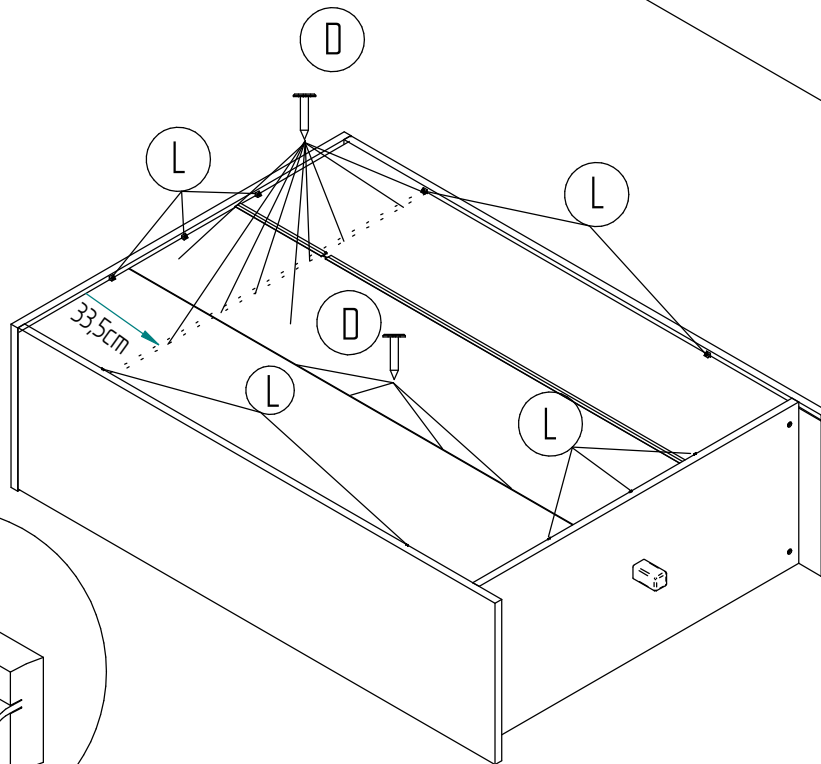

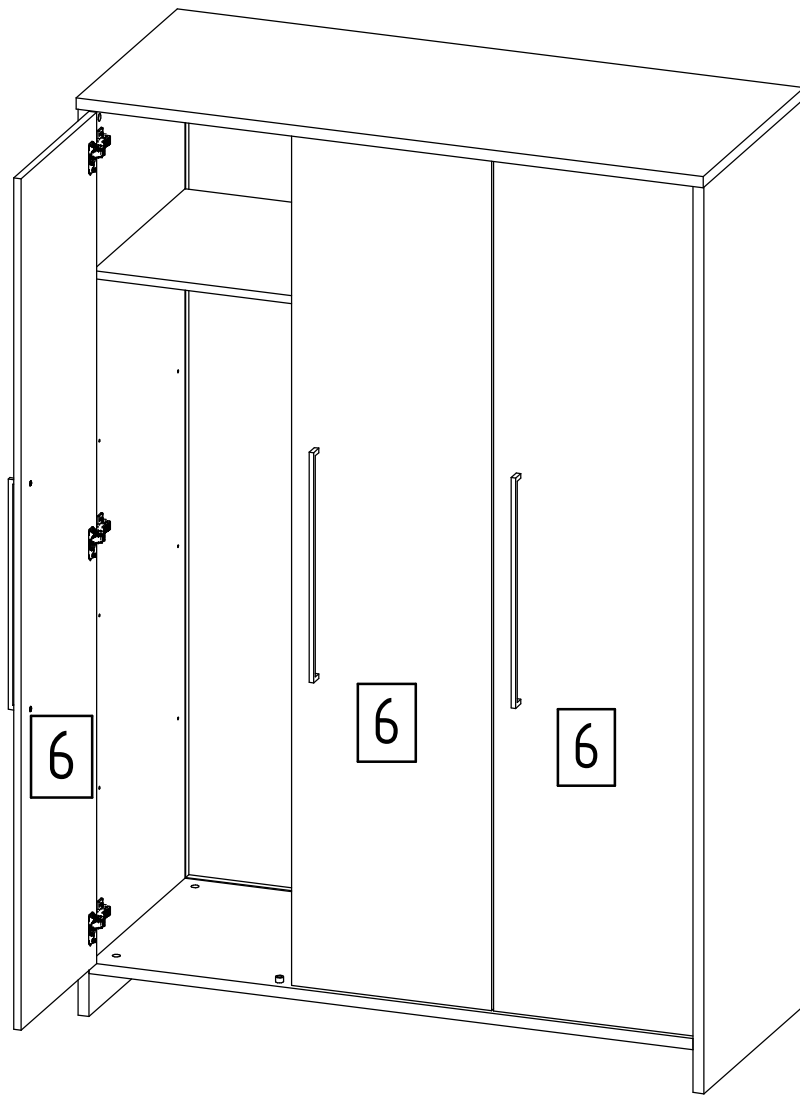

... weitere Infos über unsere Produkte unter

www.schardt.com



Schardt GmbH & Co. KG
Am Riegel 15
96268 Mitwitz
Tel. 09266/9907-0
Fax 09266/9907-77
E-Mail: info@schardt.com