

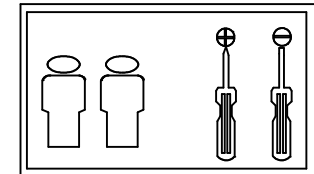









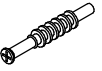



Inhalt - Contents - Contenu - Inhoud - contenuto -contenido-conteúdo - περιεχόμενο

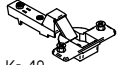
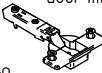

# Venice 06 231

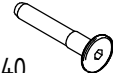
Schrank 3 Türen

Beschlagbeutel:

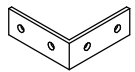
|  |   |   |  |
|--|---|---|--|
| <b>A</b><br><br>16 x              | <b>B</b><br><br>15 ohne Rand<br>20 x                   | <b>D</b><br><br>3 x 16<br>10 x                   |  |
| <b>F</b><br><br>10 x              | <b>G</b><br><br>2 x                                   | <b>H</b><br><br>16 x                            | <b>I</b><br><br>1 x              |
| <b>J</b><br>H7<br><br>9 x       | <b>K</b><br>door left/right<br>Invo Kr 18<br><br>6 x | <b>L</b><br>door middle<br>Invo Kr9<br><br>3 x | <b>M</b><br><br>2 x             |
| <b>N</b><br><br>4 x             | <b>O</b><br><br>7 x 40<br>5 x                        | <b>P</b><br><br>M4 x 20<br>6 x                 | <b>R</b><br><br>BA 288mm<br>3 x |
| <b>S</b><br><br>3,5 x 15<br>2 x | <b>T</b><br><br>1 x                                  |   |  |

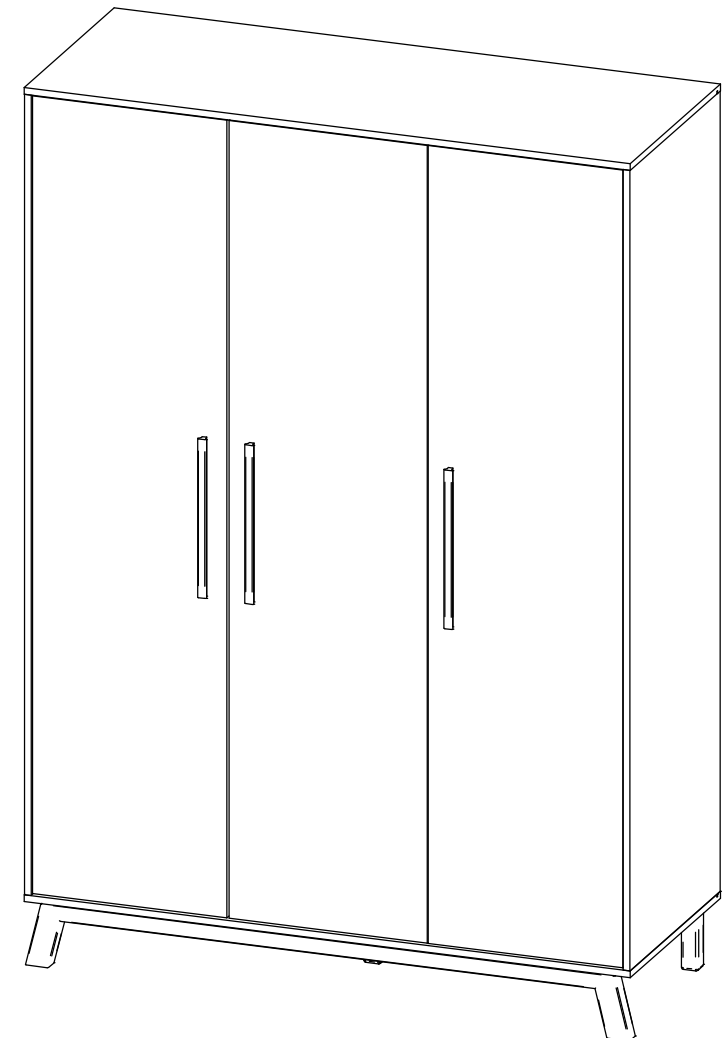
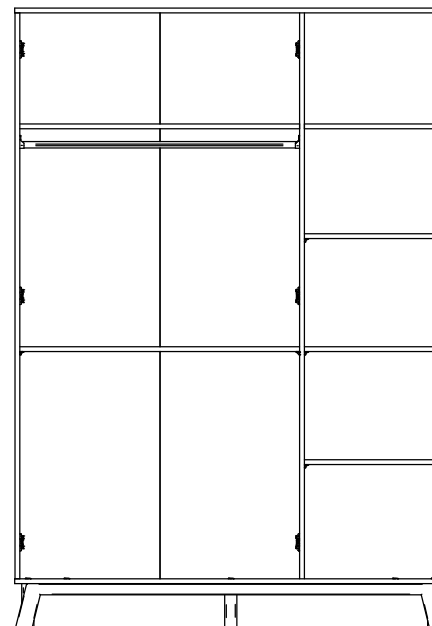

Inhalt - Contents - Contenu - Inhoud - contenuto - contenido-conteúdo - περιεχόμενο

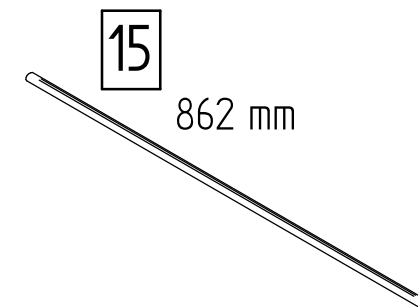
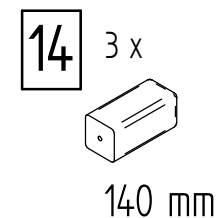
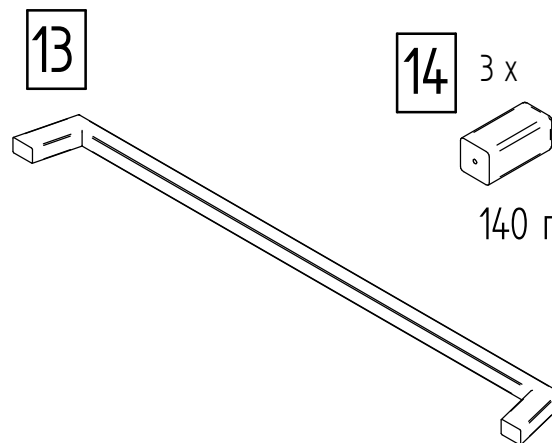
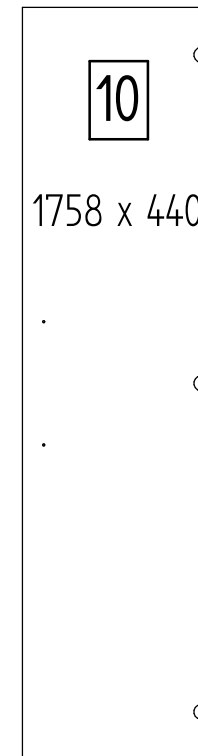
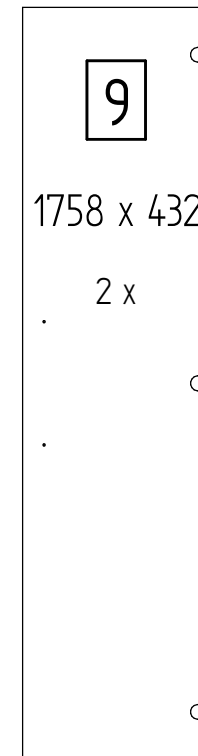
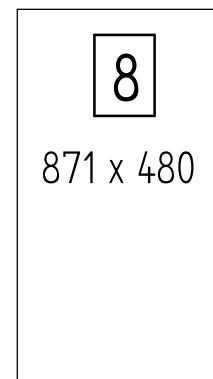
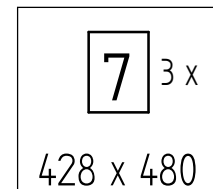
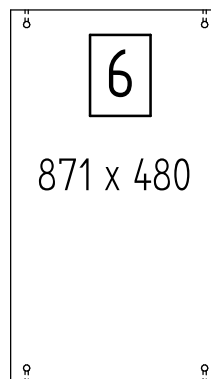
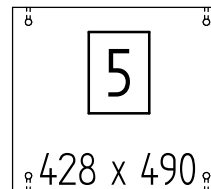
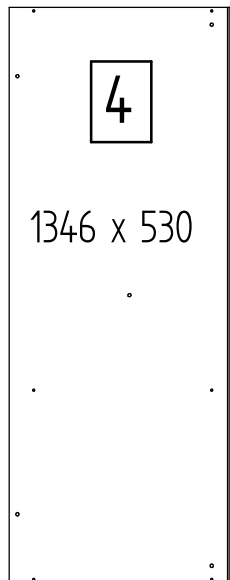
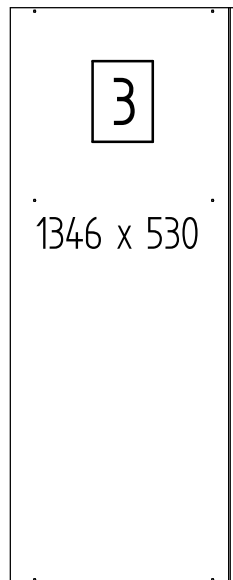
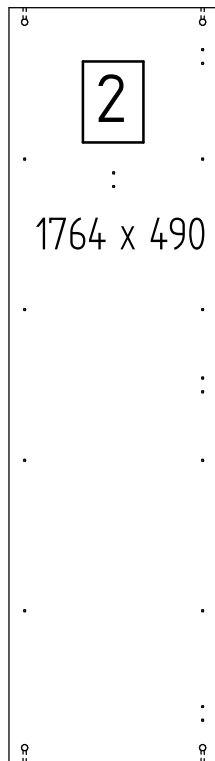
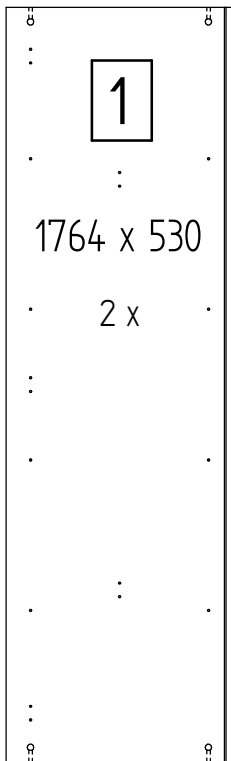

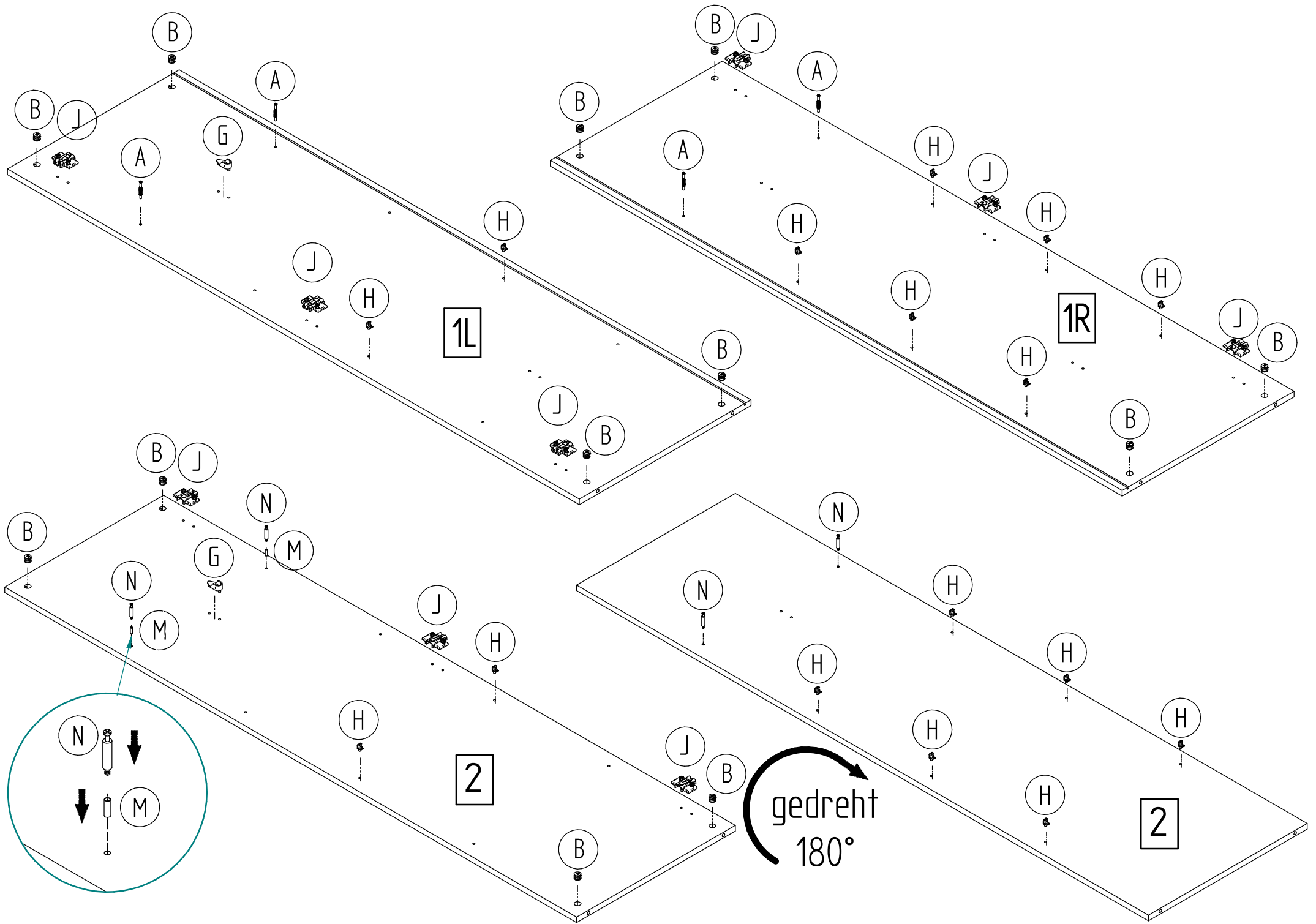

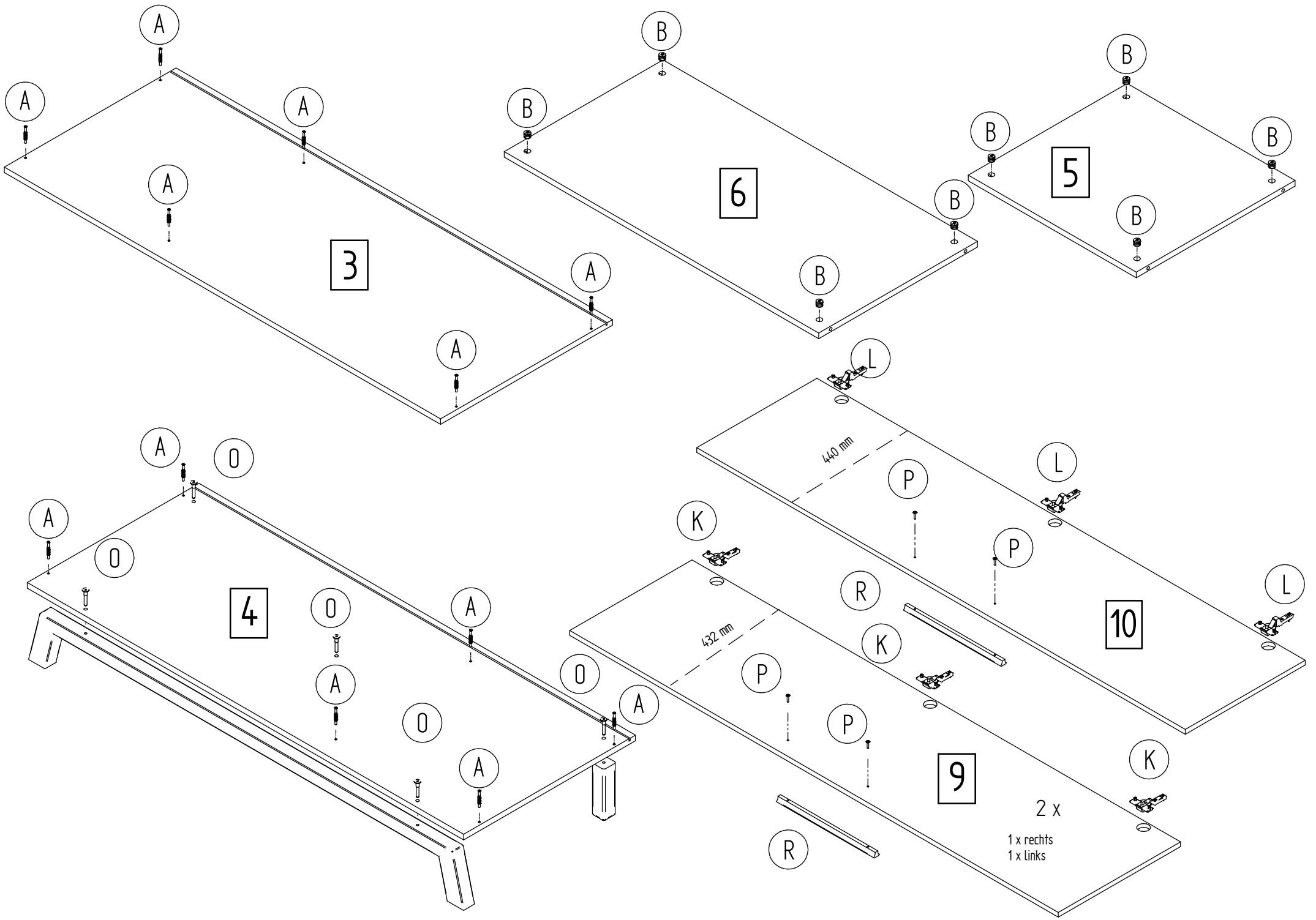

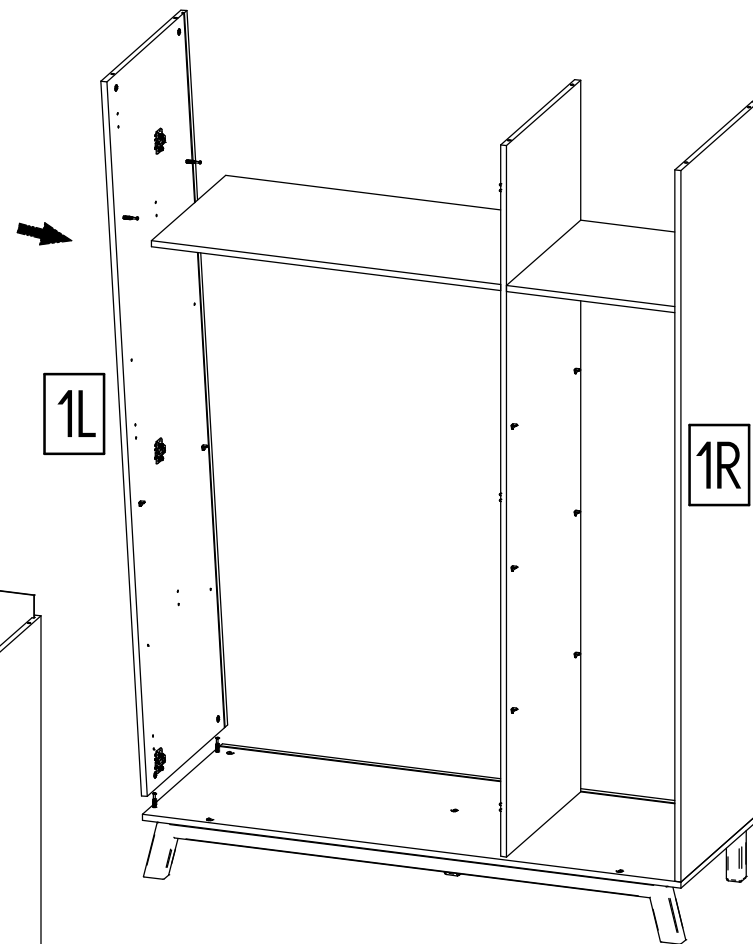
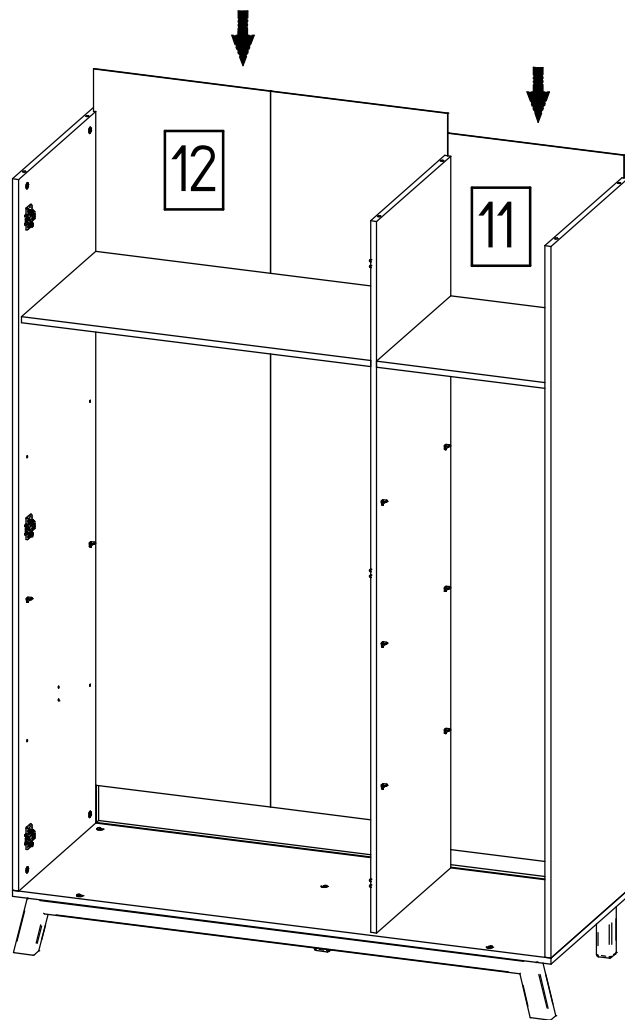
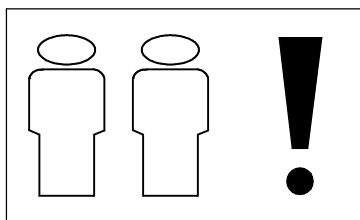
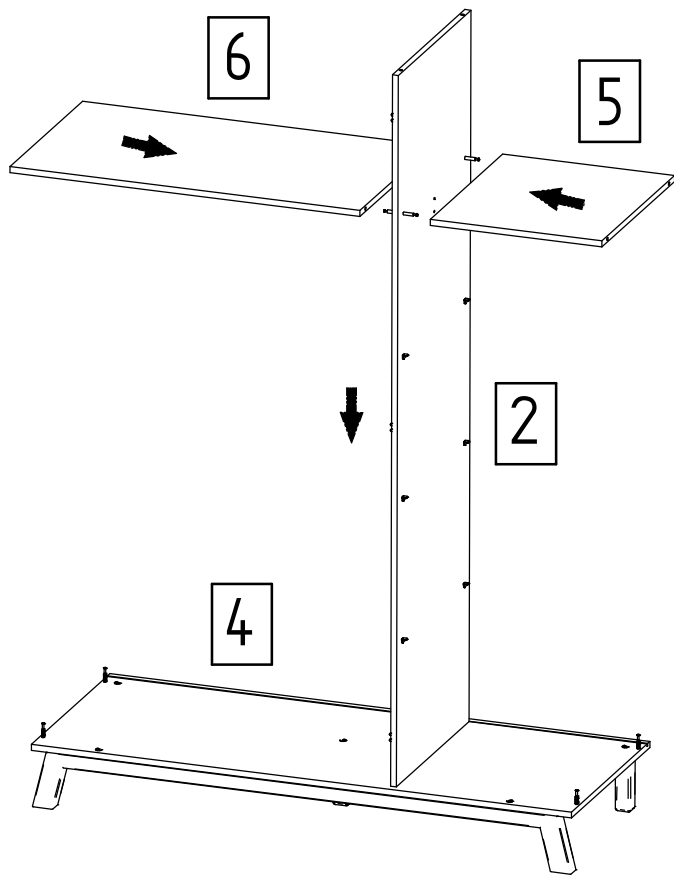

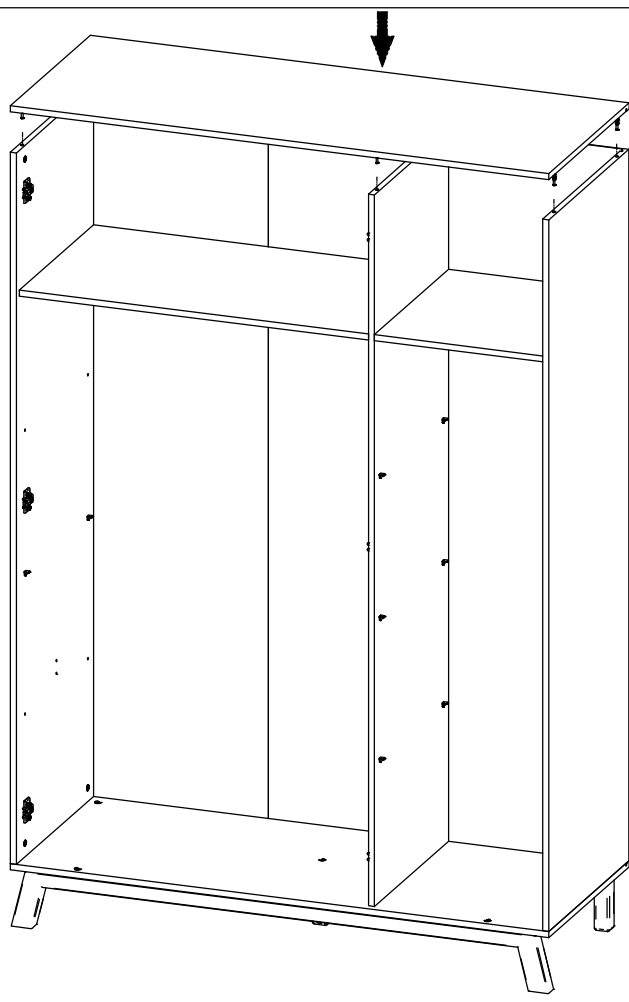

3

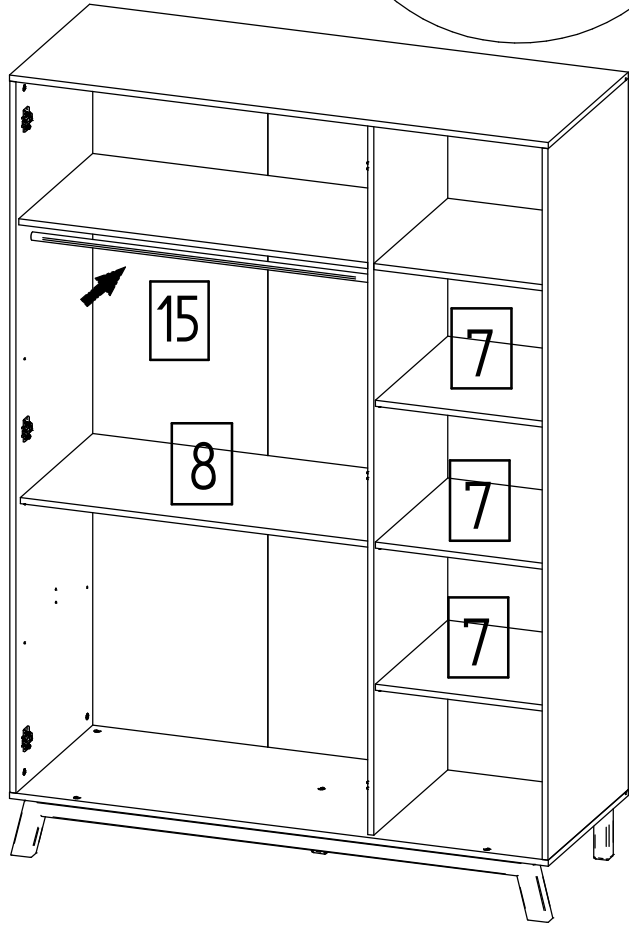
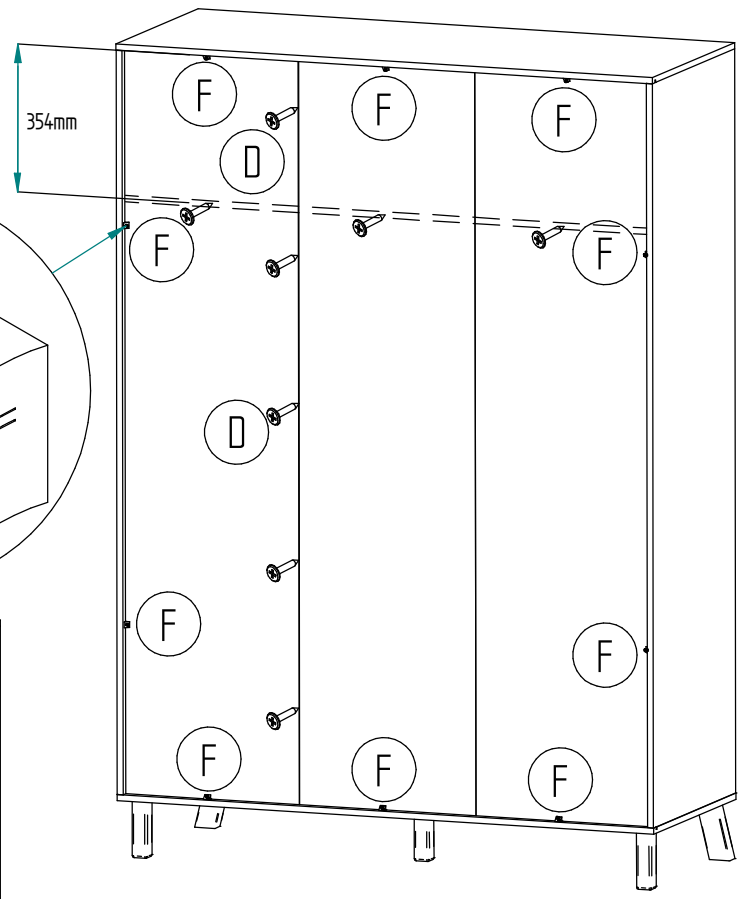
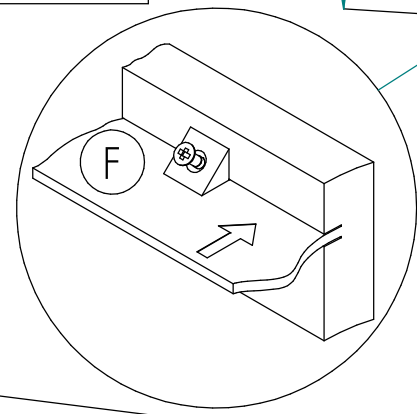
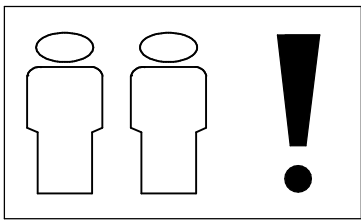

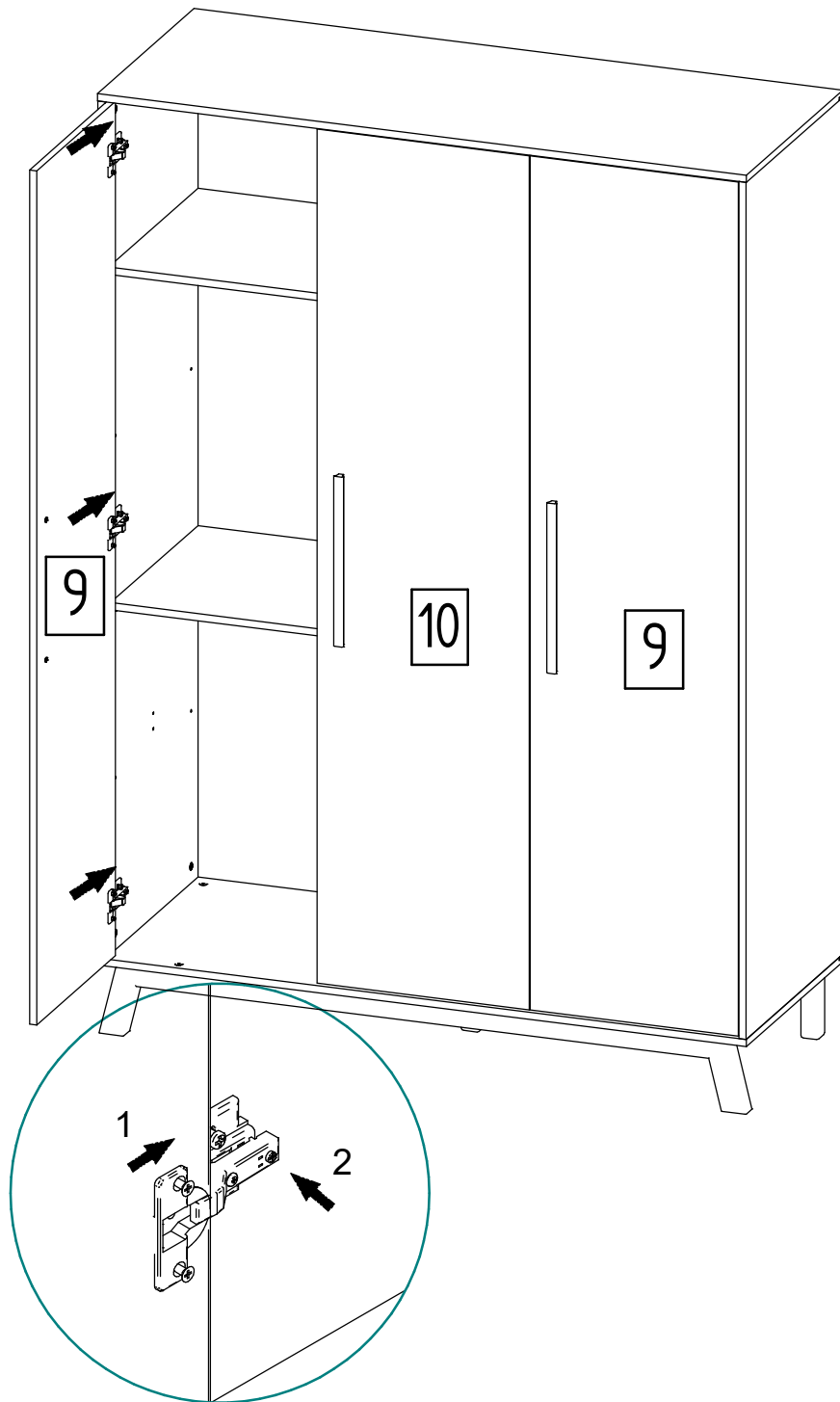

[www.schardt.com](http://www.schardt.com)

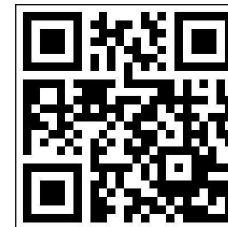

**Schardt GmbH & Co. KG**  
**Am Riegel 15**  
**96268 Mitwitz**  
**Tel. 09266/9907-0**  
**Fax 09266/9907-77**  
**E-Mail: [info@schardt.com](mailto:info@schardt.com)**

Wandbefestigung:

Den Schrank an der Wand befestigen.

Dazu beiliegenden Kippschutz mit beiliegenden Schraube S anschrauben. Anschliessend Kippschutz an der Wand befestigen. Für die Wand geeignete Dübel verwenden. Vor dem Bohren den Verlauf von Strom- und Wasserleitungen unbedingt überprüfen und berücksichtigen !

