



















Montageanleitung - Assembly instructions- instructions de montage - Montageawijzing-Istruzioni per l'installazione - indicaciones de montaje - Instruções de instalação- Οδηγίες Εγκατάστασης

Schardt GmbH & Co. KG  
 Am Riegel 15  
 96268 Mitwitz  
 Tel. 09266/9907-0  
 Fax 09266/9907-77  
 E-Mail: info@schardt.com

Inhalt - Contents - Contenu - Inhoud - contenido - contenido-conteúdo - περιεχόμενο  
 Wickelkommode changing unit Commode Kommode

# Wiko Miami 05 795 Typ 1

DIN EN 12221:2008+A1:2013

A		8 x	B		8 x	F		12 x	I		12 x	J		4 x	
C		8 x 30	D		4 x 30	H		1 x	L		3 x	M		8 x	
G		SW 4							N		288mm Holz	3 x	R		M6 x 45
K		3 X 450 mm							P		4 x	Q		4 x	
O		M4 x 20													

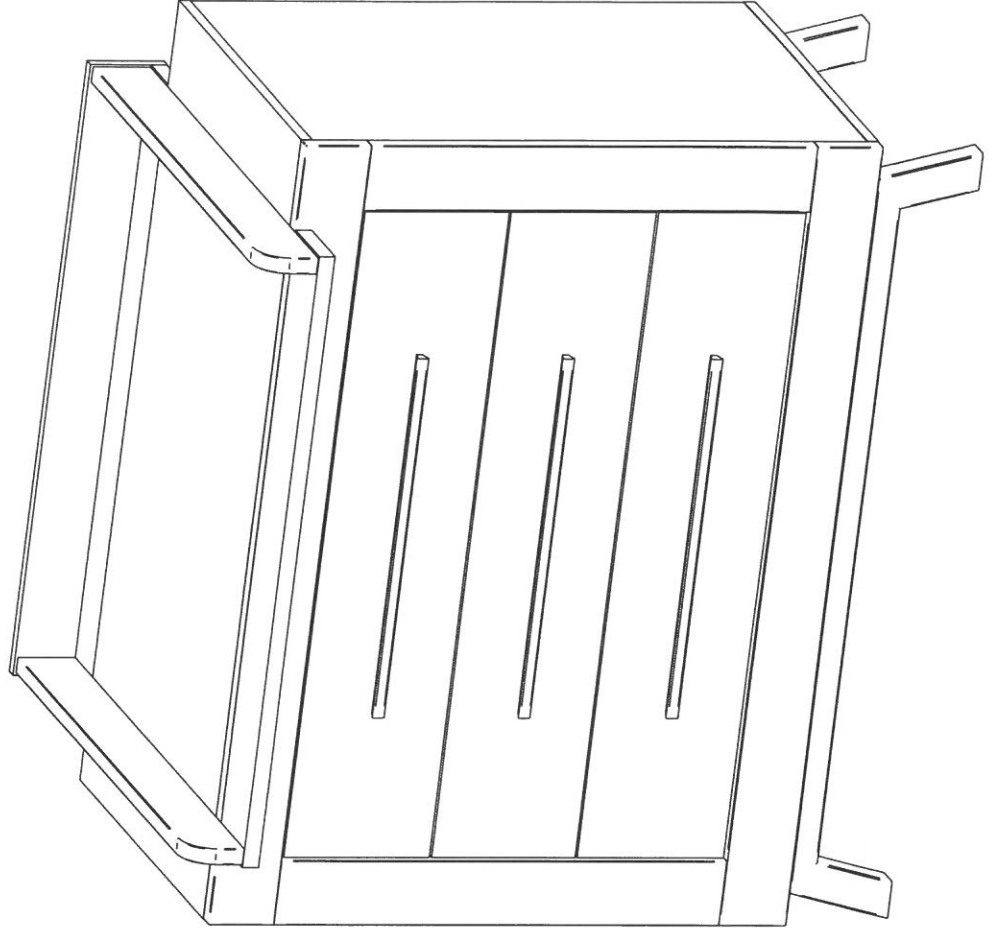
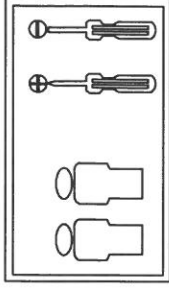



Montageanleitung - Assembly instructions - instructions de montage - Montageaawijzing-Istruzioni per l'installazione - indicaciones de montaje - Instruções de instalação- Οδηγίες Εγκατάστασης

Schardt GmbH & Co. KG  
Am Riegel 15  
96268 Mitwitz  
Tel. 09266/9907-0  
Fax 09266/9907-77  
E-Mail: info@schardt.com

Inhalt - Contents - Contenu - Inhoud - contenido - conteúdo - περιεχόμενο

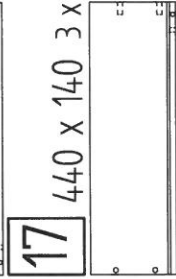
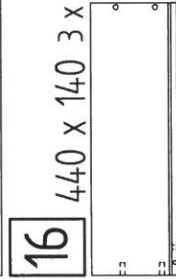
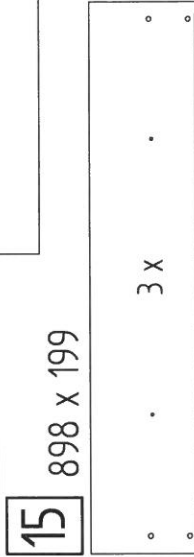
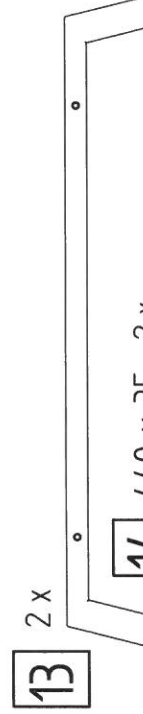
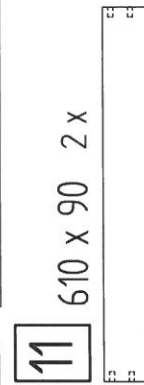
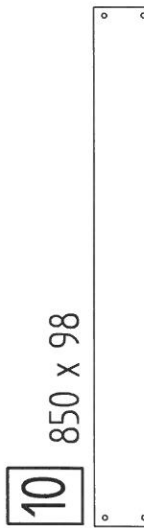
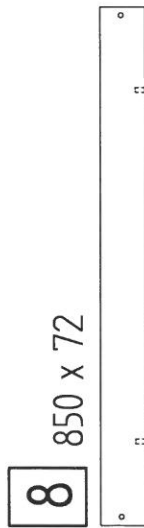
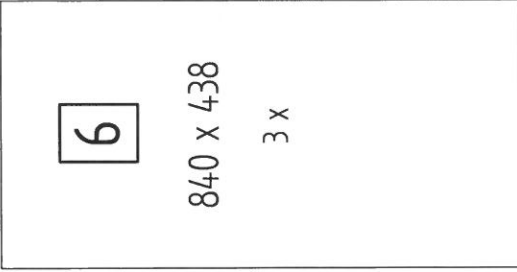
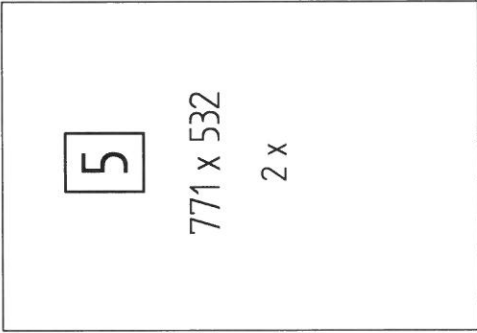
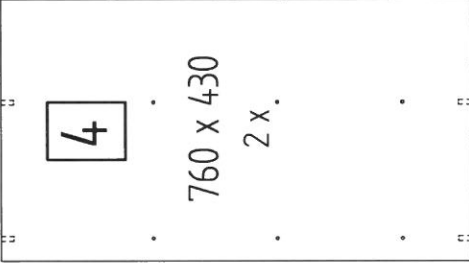
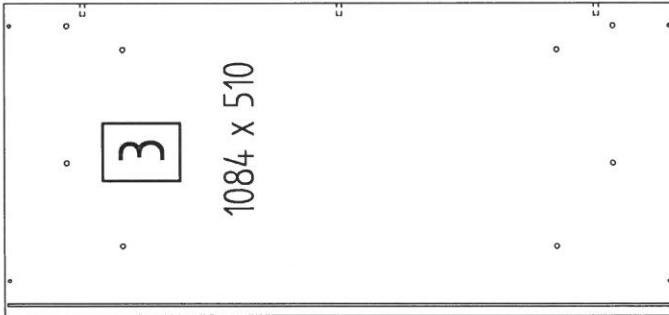
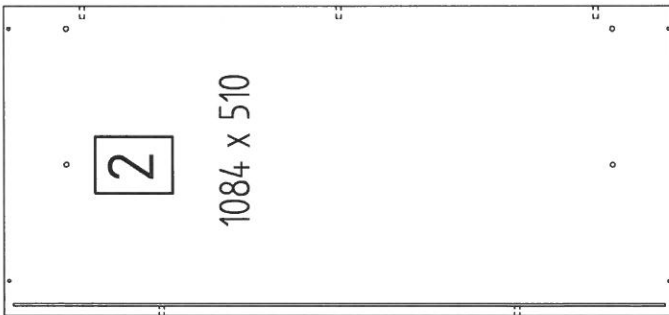
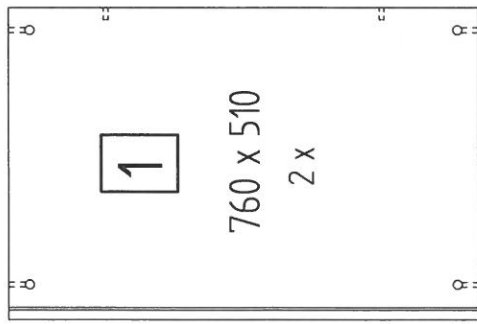

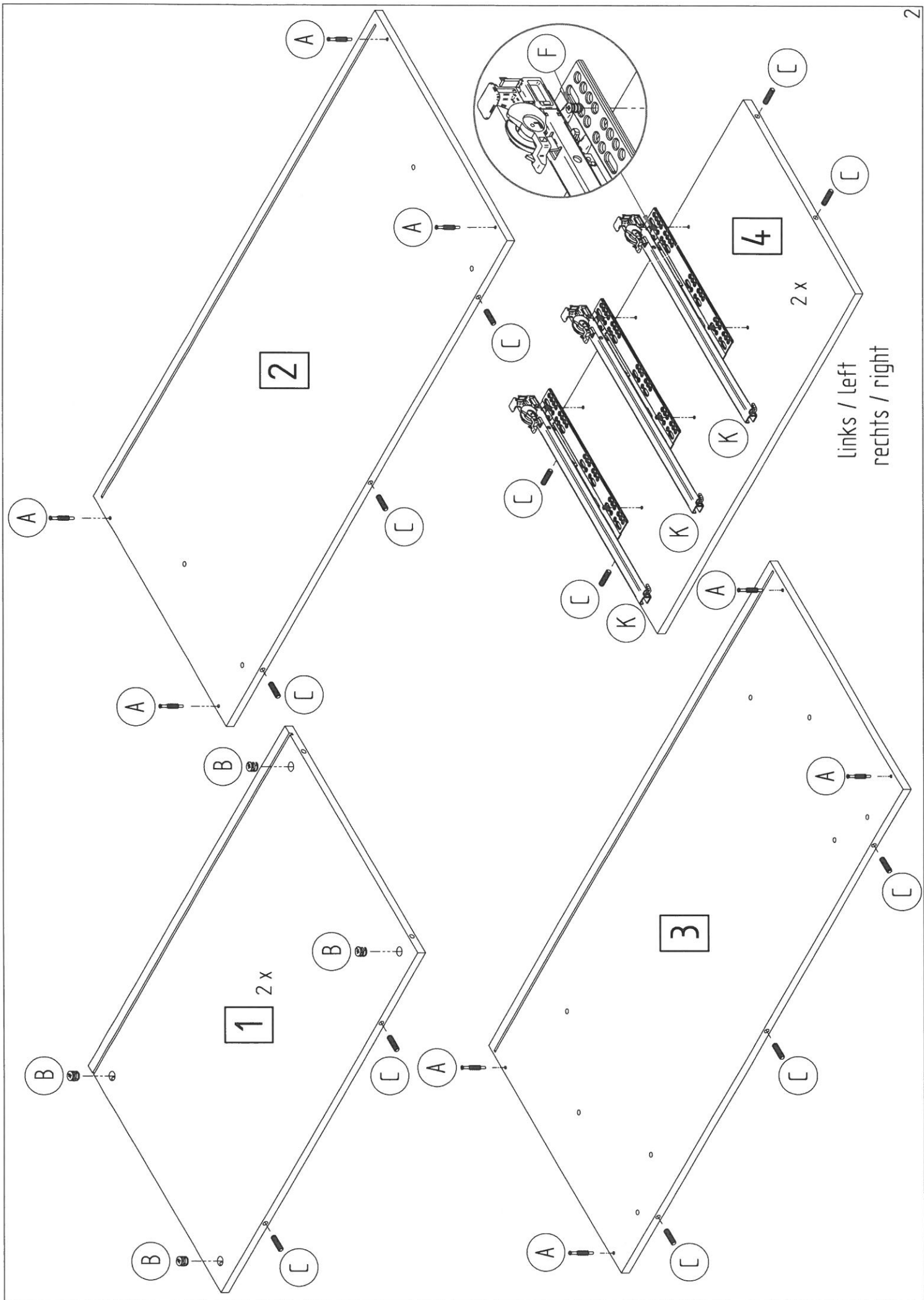

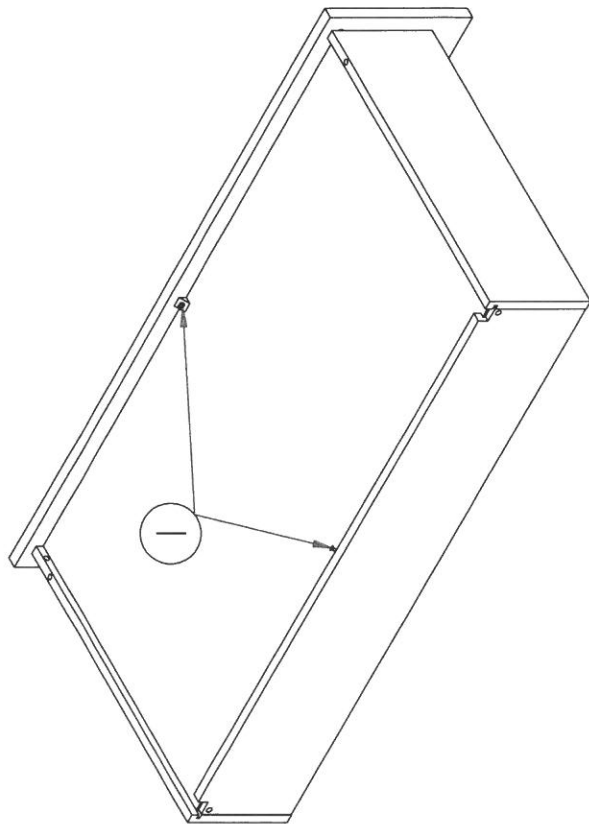
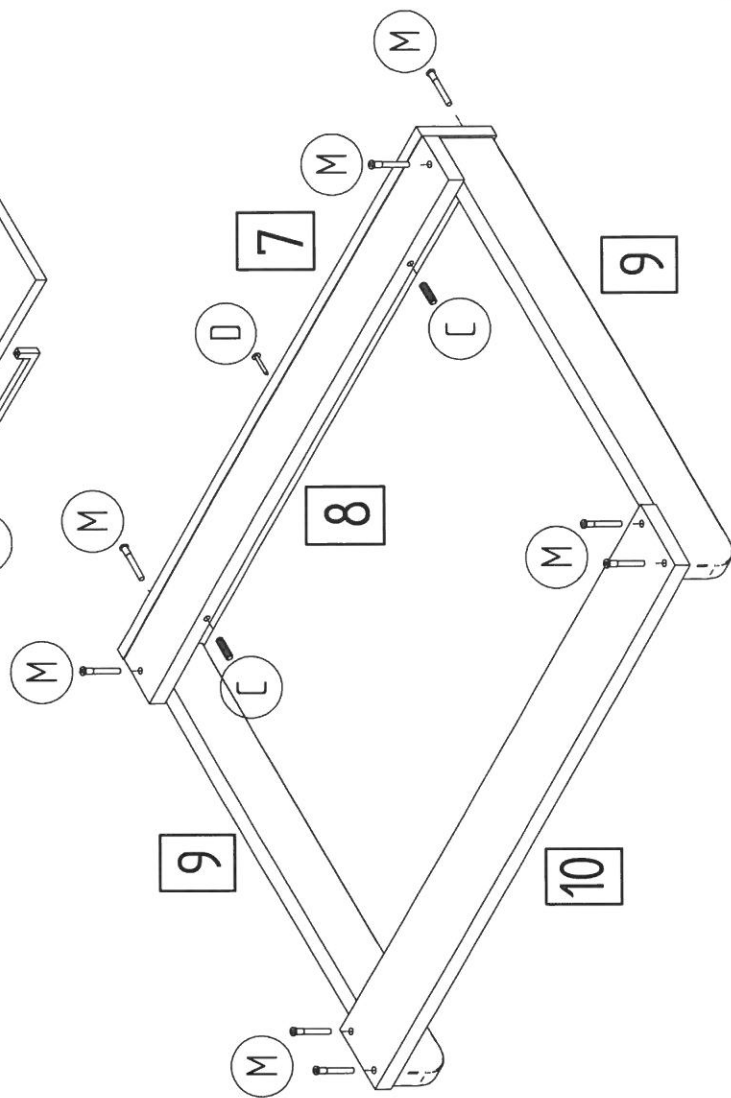
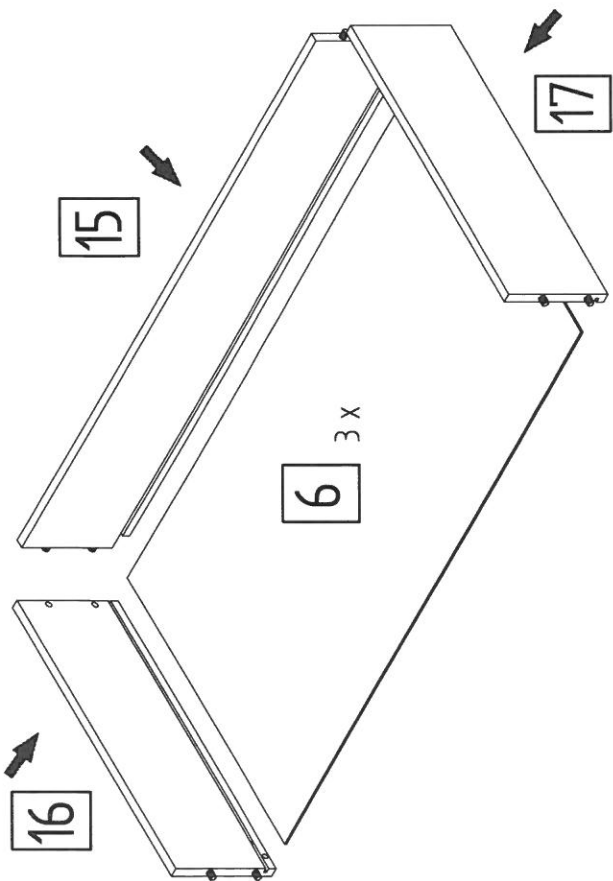
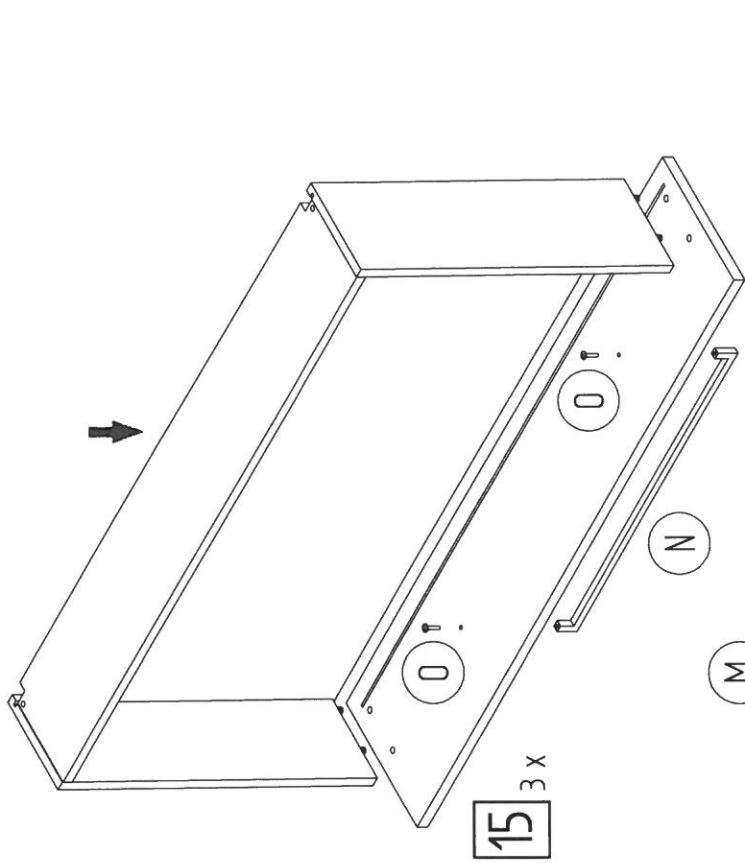

Vormontage:

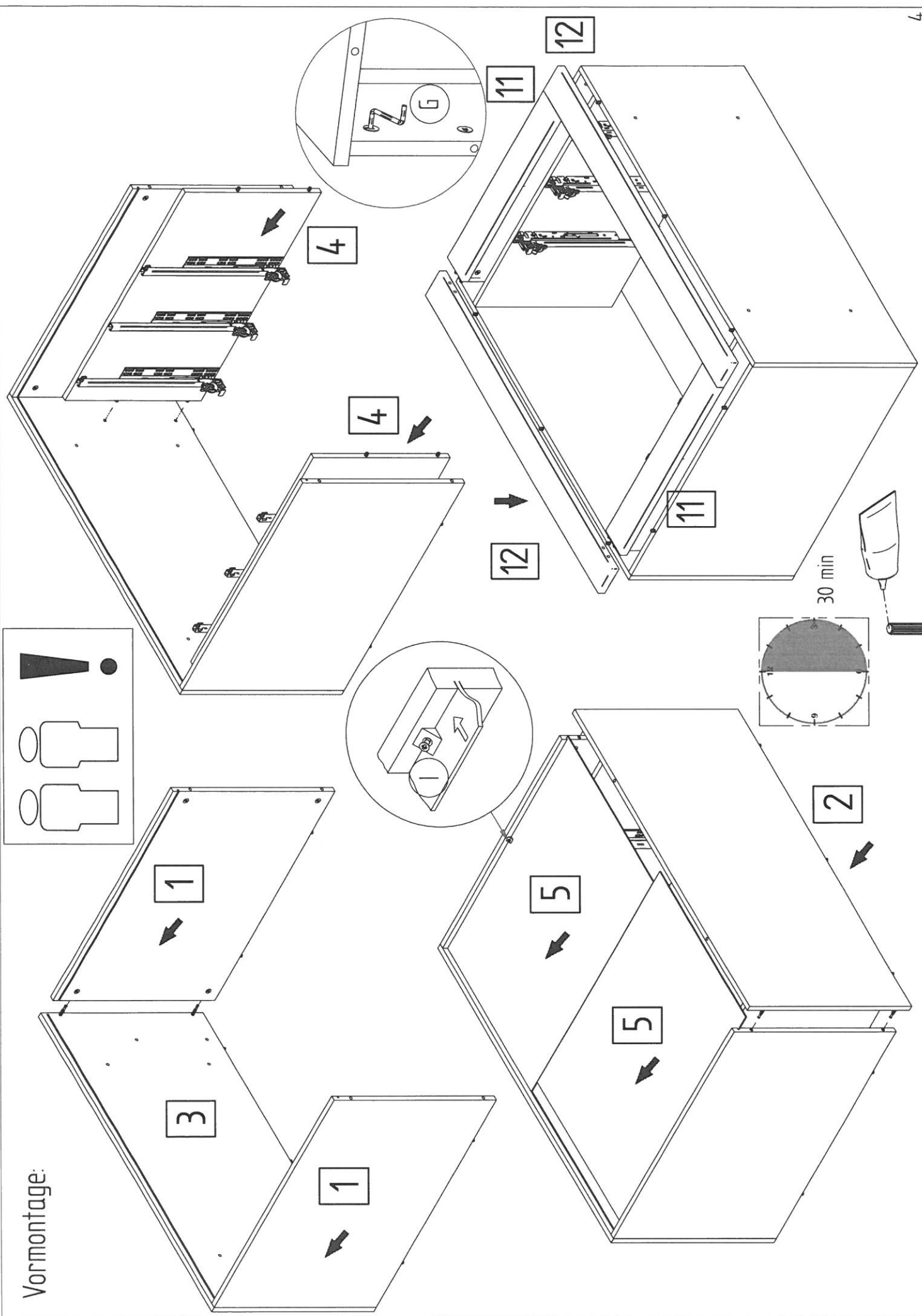

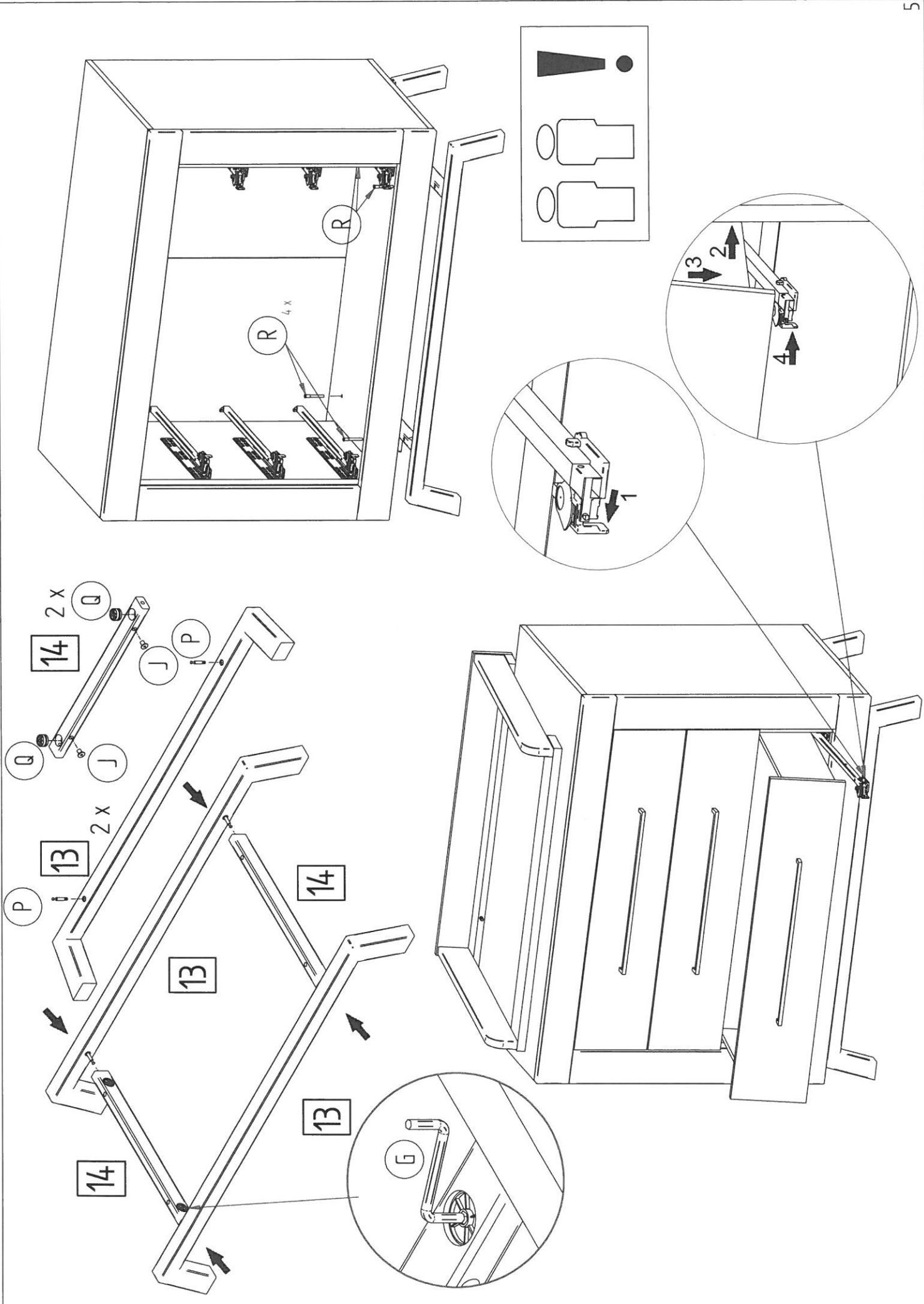

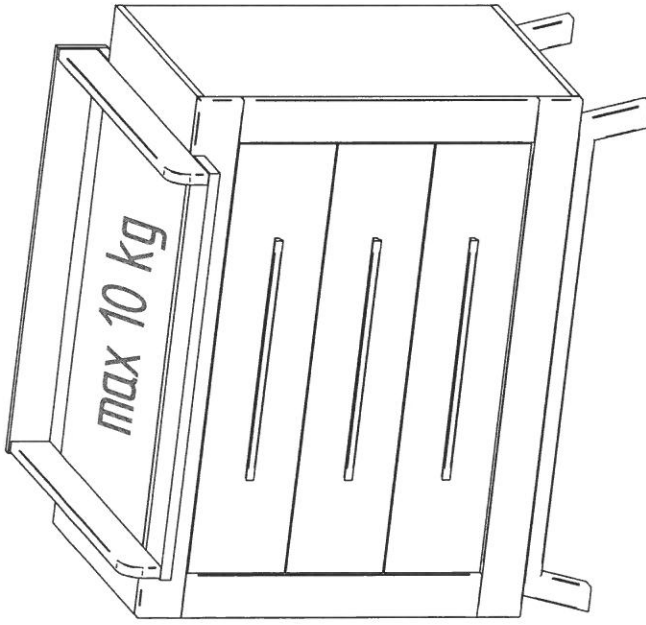

**Achtung !**

Wird die Wickelkommode an der Wand befestigt , muss das Montagematerial der Beschaffenheit der Wand entsprechen !

**Attention !**

If the baby changing table is attached to the wall the assembly material has to be appropriate for the composition of the wall !

**Attention !**

Si la table à langer est attachée au mur il doit être approprié le matériel d'asssemblage pour la composition du mur !

**Attenzione !**

Si il fasciatoio é fortificato al muro il deve essere appropriato il materiale di montaggio alla composizione del muro !

... **weitere Infos über unsere Produkte unter**  
... plus d'informations sur nos produits sous  
... altre informazione degli prodotti di noi sotto

[www.schardt.com](http://www.schardt.com)



**Schardt GmbH & Co. KG**  
Am Riegel 15  
96268 Mitwitz  
Tel. 09266/9907-0  
Fax 09266/9907-77  
E-Mail: [info@schardt.com](mailto:info@schardt.com)

